



700 SERIES



DESCRIPTION

The Curtis 700 Series are highly reliable solid state hour meters and counters that offer an unprecedented combination of patented technology, performance, reliability and value.

MODEL 700: 2-Wire Hour Meter, displays only when powered. Available in AC/DC.

MODEL 701: 3-Wire Hour Meter, has a provision or continuous display. Available in AC/DC and DC-only.

MODEL 703: Pulse Counter. Available in AC/DC and DC-only.

APPLICATIONS

A wide variety of industrial and commercial applications, including scheduled maintenance, warranty and leasing – for medical equipment, transport and industrial vehicles and other industrial equipment.

FEATURES

- All-8's LCD function test: each digit displays an eight for one second after power-up.
- Attractive 6-digit LCD 5mm or 7mm high digits (7mm with optional backlighting) are much easier to read than electro-mechanical meters, which have only 3mm high digits.
- Silent operation – no moving parts. Eliminates annoying gear and motor noise.
- Exceptional reliability due to nonvolatile memory (EEPROM) which retains data for 25+ years.
- Wide voltage ranges, for example, one unit can be powered from 75 to 270 VAC anywhere between 48 and 440 Hz – ideal for distribution and worldwide markets without having to stock multiple model types.
- Electrical reset (optional).
- Available in ten case styles – all fit in standard hour meter/counter cutouts.
- Multiple mountings available – Metal U-bracket, "U" clamp/stud (D, Q, R and S cases), flange mount with hardware (F, G, J cases), or mounting clip (G, L, Y, Z, cases).
- Backlit units allow external illumination control, i.e., on/off or dimmer (12VDC only).
- Flashing hourglass icon indicates when the hour meter is accumulating time.
- Memory will arm only when power has been applied for five seconds (with no loss of time or counts).
- Low power consumption.
- UL and CE recognized.

CURTIS INSTRUMENTS, INC.
200 KISCO AVENUE
MT. KISCO, NY 10549 USA
TEL (914) 666-2971
FAX (914) 666-2188

CURTIS INSTRUMENTS, (UK) LTD.
5 UPPER PRIORY STREET
NORTHAMPTON NN1 2PT, ENGLAND
TEL 44 (0) 1604-629755
FAX 44 (0) 1604-629876

**CURTIS INSTRUMENTS INDIA
PRIVATE LTD.**
1199, GHOLE ROAD
PUNE 411004, INDIA
TEL 91 (0) 20-5531288
FAX 91 (0) 20-5539192

700 SERIES

SPECIFICATIONS

Case Style	Bezel Shape	Lens Material	Case Material	IP Rating Front/Rear	Termination	UL ⁵ /CE	Suggested Panel Cutout mm
D	Rectangular	Acrylic	ABS	65/50	3/16" Spade	Yes	45.0 x 22.2
F	Hexagonal	Acrylic	ABS	65/65	1/4" Spade	Yes	36.8 x 24.1
G	Hexagonal	Acrylic	ABS	65/651	Packard (2 pin) 2	Yes	36.8 x 24.1
J	Hexagonal	Acrylic	ABS	65/651	Packard (4 pin) 3	Yes	36.8 x 24.1
L	Rectangular	Polycarbonate	Polycarbonate	65/40	Molex 4	Yes	36.8 x 24.1
Q	Round	Glass	Polycarbonate	65/506	1/4" Spade	Yes	ø52 (ø2-1/16)
R	Round	Glass	Polycarbonate	65/506	3/16" Spade	Yes	ø52 (ø2-1/16)
(5mm display)							
R	Round	Glass	Polycarbonate	65/50	1/4" Spade	Yes	ø52 (ø2-1/16)
(7mm display)							
S	Square	Glass	ABS	52/50	1/4" Spade	Yes	45.0 x 45.0
Y	Rectangular	Acrylic	ABS	65/651	Packard (4 pin) 3	Yes	36.8 x 24.1
Z	Rectangular	Acrylic	ABS	65/65	1/4" Spade	Yes	36.8 x 24.1

Display	6 digit LCD, 5 or 7mm high
Range & Resolution	Hour meters: 99,999.9 hours Counters: 999,999 counts
Accuracy	Hour meters: 0.1% Counters: ±1 count
Humidity	95%, non-condensing at 38°C
Operating Temperature	-40°C to +85°C
Storage Temperature	-50°C to +85°C
Mechanical Shock	SAE J 1378, 55g
Mechanical Vibration	SAE J 1378, 20g
Operating Frequency (AC powered units)	48 to 440 Hz
Memory	Main power must be applied for 5 seconds to arm memory (with no loss of time/counts). EEPROM, data retained for 25+ years without power.
Current Consumption (Power Terminals)	0.5mA max. @ 5VDC (0512D models) 0.8mA max. @ 12VDC (1248D models) 1.0mA max. @ 120VAC 2.0mA max. @ 230VAC
Input Signal (DC-only)	Counters (703 only): 500 Hz. max., 50% duty cycle (1ms low, min., between consecutive highs)
Input Signal (AC/DC)	Hour meters (701 only): Power must be applied for 0.5s, min., to accumulate time. Counters (703 only): 1 Hz. max., 50% duty cycle (500ms low, min., between consecutive highs)
Reset	5ms min. at operating voltage. Main power must be applied for a minimum of 250ms prior to reset signal.

NOTES:

1. Mating connector must be installed.
2. Equivalent to Delphi-Packard connector P/N 12162000 2-pin.
3. Equivalent to Delphi-Packard connector P/N 15336035 4-pin.
4. Equivalent to Molex connector P/N 43045-0412.
5. UL files AU1841 and E45175.
6. R(5mm) and Q housings also available in a 65/65 version (see model encodement).

700 SERIES

MODEL ENCODING

700 MODEL	R Case Style	R Resetability	001 Additional Feature	O Logo*	0512D0612A Operating Voltage
700 = (2-wire hour meter, AC/DC only)	D F G ¹	R = Electrically	001 = 5mm, non-backlit display (Standard)	O = Curtis Logo N = No Logo	0512D = 5-12VDC nom., 4.75-15VDC abs.
701 = (3-wire hour meter, AC/DC or DC-only)	J L ² Q		091 = Epoxy filled unit (moisture resistant, Q, R (5mm), cases only)		1248D = 12-48VDC nom., 9-60VDC abs.
703 = (3-wire counter, AC/DC or DC-only)	R S Y Z		601 = 7mm, backlit display (R or S case only)		48150D = 48-150VDC nom., 36-185VDC abs.
			701 = 7mm, non-backlit display (R or S case only)		0512D0612A = 5-12VDC nom., 4.75-15VDC abs. 6-12VAC nom., 5-15VAC abs.
					1248D2060A = 12-48VDC nom., 9-60VDC abs. 20-60VAC nom., 15-75VAC abs.
					48150D100230A = 48-150VDC nom., 36-185VDC abs. 100-230VAC nom., 75-270VAC abs.

1. Only model offered: 700GN001N1248D2060A

2. Only models offered: 700LN001N1248D2060A, 700LN001N48150D100230A and 701LN001N1248D

* Custom logos are available
Backlight available on 7mm R or S cases only.

WIRING GUIDE

Case Style	Pin 1	Pin 2	Pin 3	Pin 4	Pin 5	Pin 6
D, F, J, Q, R (5mm), Y & Z	V+	V-	I	R	N/A	N/A
G	V+	V-	N/A	N/A	N/A	N/A
L	V+	V-	I	N/A	N/A	N/A
R (7mm), S	V+	V-	R	I	L	N/A

V+ Operating voltage

V- Common (ground)

I Enable (Optional, use operating voltage to power this pin to record elapsed time (701) or increment count (703).)

R Reset (Optional, supply with operating voltage when unit is to be reset to 0.)

L Lighting control (Optional, 9-15VDC absolute only, regardless of operating voltage.)

NC No connection

DIMENSIONS IN MM

Case Style D

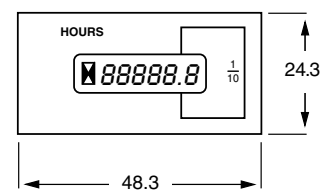
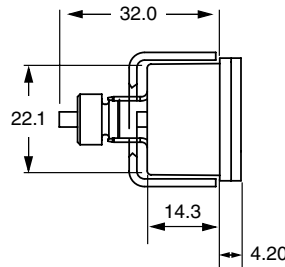
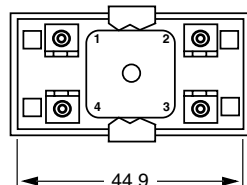

700 SERIE

DIMENSIONS IN MM

Case Style F

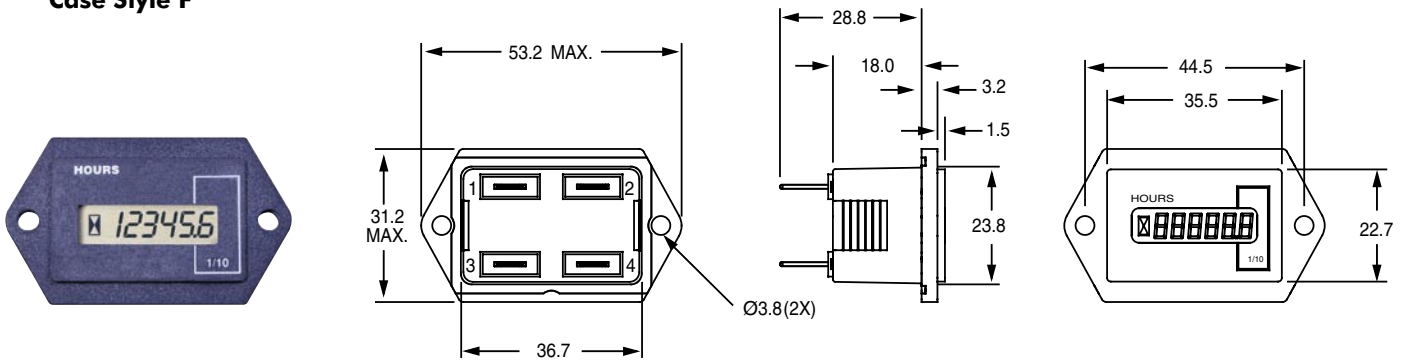

Case Style G

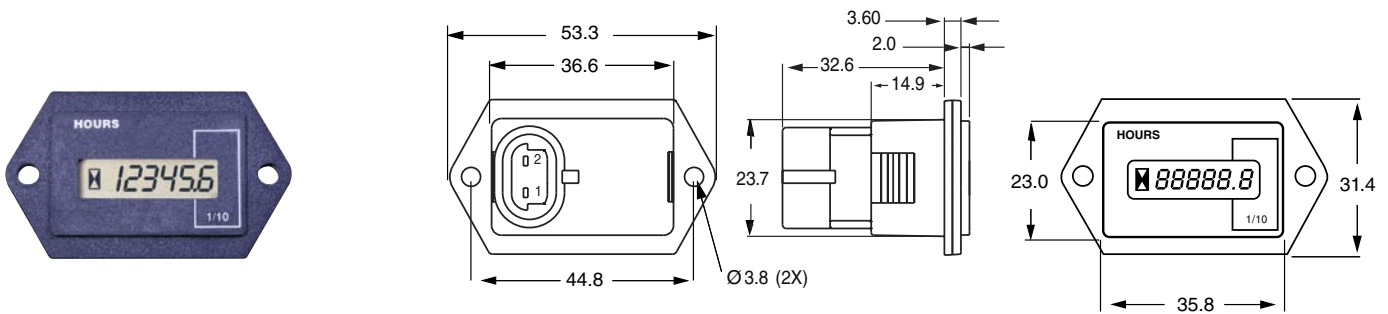

Case Style J

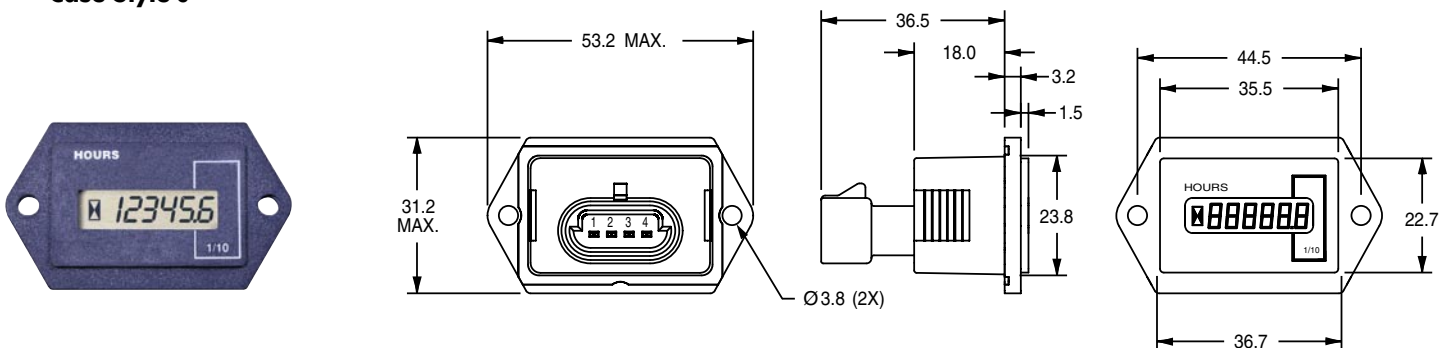

DIMENSIONS IN MM

Case Style L

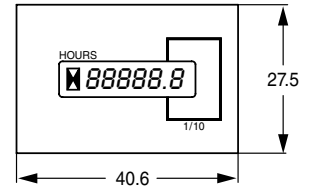
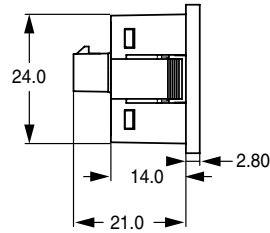
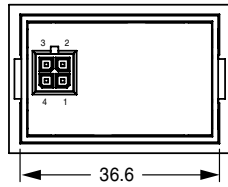

Case Style Y

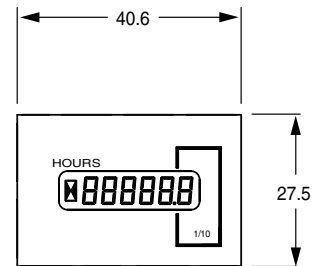
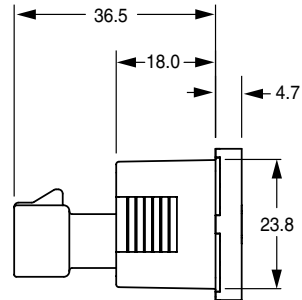
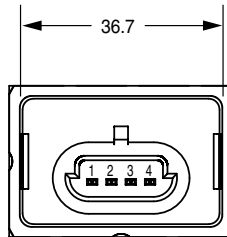

Case Style Z

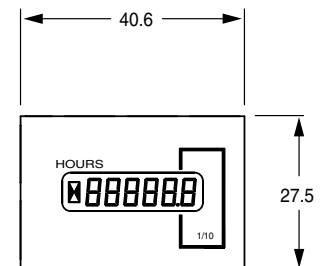
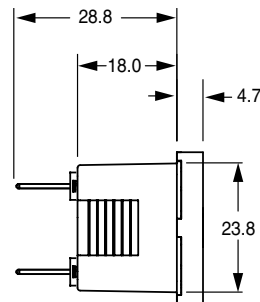
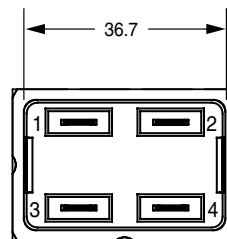

DIMENSIONS IN MM

Case Style Q

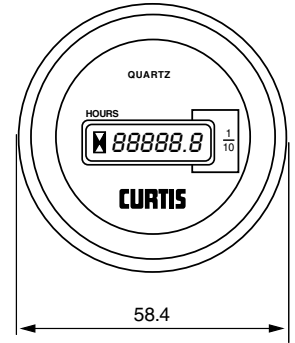
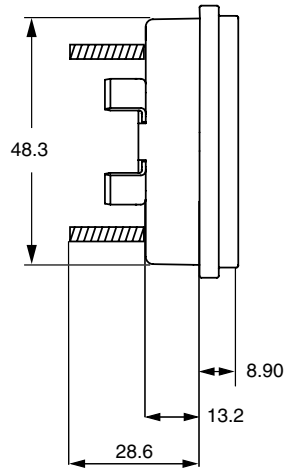
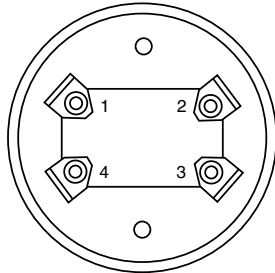

Case Style R (5mm)

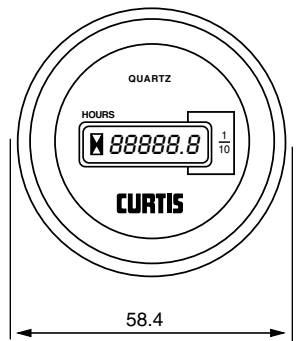
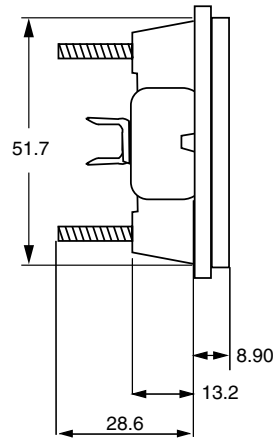
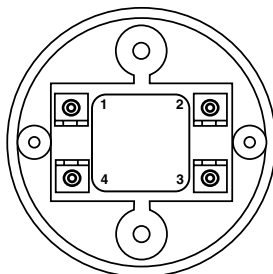

Case Style R (7mm)

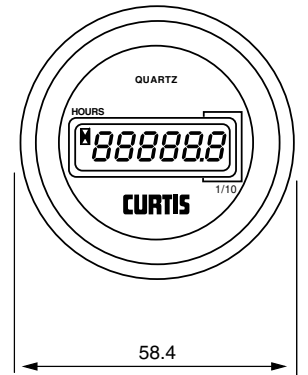
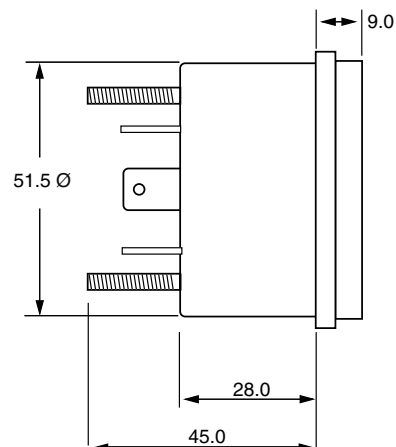
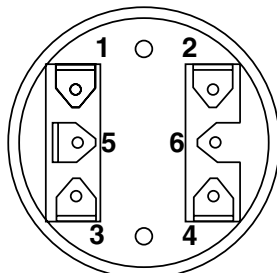

DIMENSIONS IN MM

Case Style S

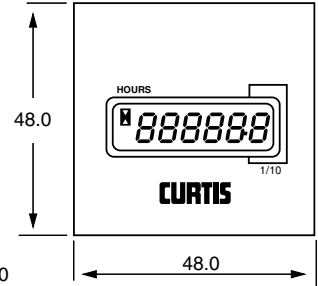
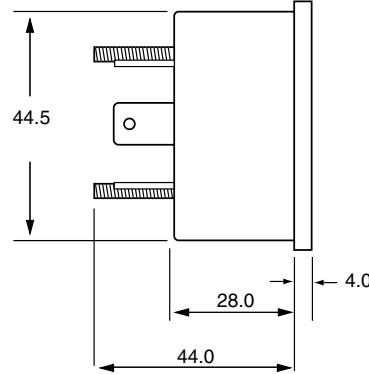
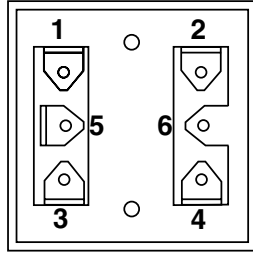
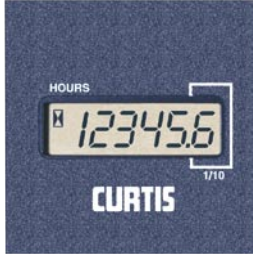

700 SERIES HARDWARE

Case Style	F		G, J		D, Q, R, S		Y		Z	
Shipping Style	Carton	Bulk	Carton	Bulk	Carton	Bulk	Carton	Bulk	Carton	Bulk
Steel Slot Screws	2	2	2	2						
Steel Hex Nuts		2		2		2				
Plastic Thumb Nuts	2		2		2					
Lock Washers	2	2	2	2	2	2				
Faston Terminals	4				4				4	
Plastic Bracket							1	1	1	1
Metal U Bracket					1	1				

Note: L case does not require hardware.

ACCESSORIES

Curtis P/N	Description
17607303	Plastic mounting bracket for F, G, J, Y & Z models
17607800	100 mounting clips for F, G, J, Y & Z case
12237003	Dash Mounting Bracket, L-shape
13210001	Meter Guard (1 box of 10 meter guards) R & Q models
13515801	3-Hole Mounting Kit, for Ø2.53" mounting holes
13515905	3-Hole Mounting Kit, for Ø2.44" mounting holes
15336002	Gasket for F, G and J cases
15336003	Gasket for R (5mm) case
15336005	Gasket for Q and R (7mm) cases

WARRANTY: Two-year replacement warranty.

