

DETAILS

Product Number	CA11483_LXP2-M
Family	Leila
Type	Assembly
Color	black
Diameter	21,6 mm
Height	14,7 mm
Style	round
Optic Material	PMMA
Holder Material	
Fastening	tape
Status	production ready
ROHS Compliant	Yes
Date Updated	10/04/2014



OPTICAL PROPERTIES

LED	Viewing	Light	Effi-		Connector
	Angle	Beam	ciency	cd/lm	
XT-E	24 deg	Medium	88 %	3.900	-
XP-G	24 deg	Medium	94 %	-	-
XP-E-HEW	23 deg	Medium	93 %	-	-
XP-E	23 deg	Medium	94 %	4.600	-
XP-G2	23 deg	Medium	90 %	5.000	-
XP-E2	23 deg	Medium	88 %	5.200	-
XP-L HI	24 deg	Medium	87 %	4.700	-
H35B0 (LEMWA32)	24 deg	Medium	90 %	4.900	-
H35C1 (LEMWA33)	25 deg	Medium	87 %	4.600	-
LUXEON Q	24 deg	Medium	87 %	4.300	-
Z5	sim: 25	Medium	91 %	-	-
Z5M1/Z5M2	26 deg	Medium	87 %	4.700	-
Z8Y22P	sim: 26	Medium	sim: 89 %	sim: 3.860	-

Relative intensity of CA11483_LXP2-M-(XPE2)

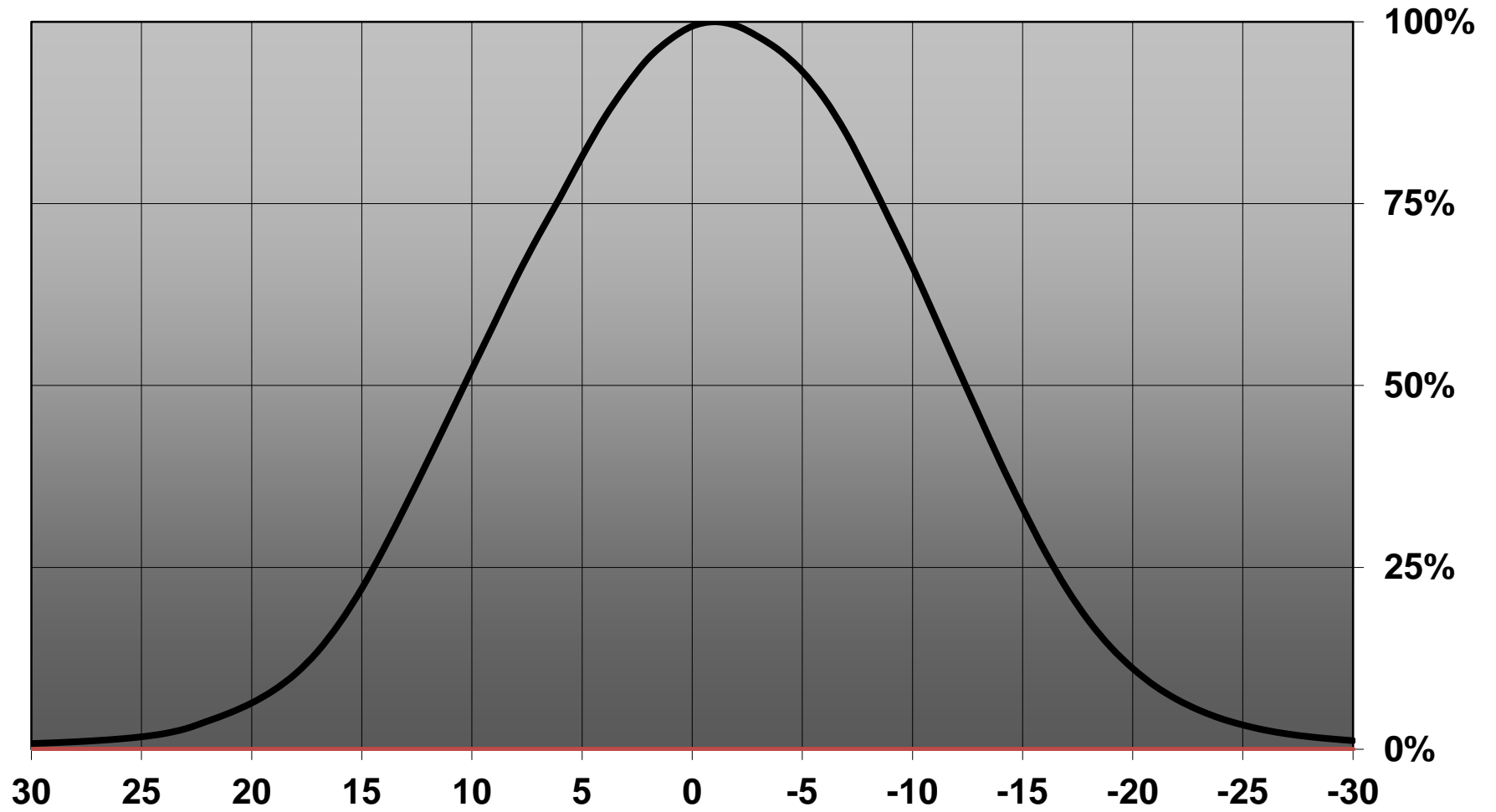

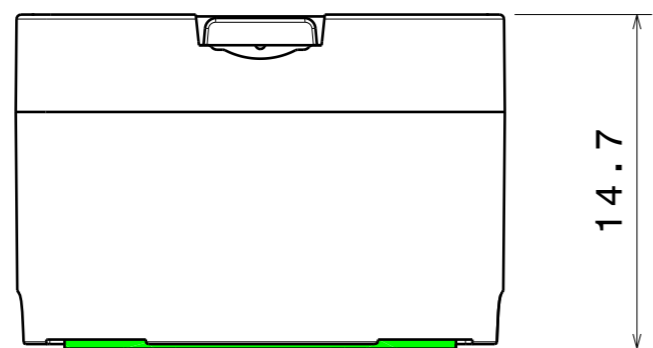

Front view
Scale: 3:1

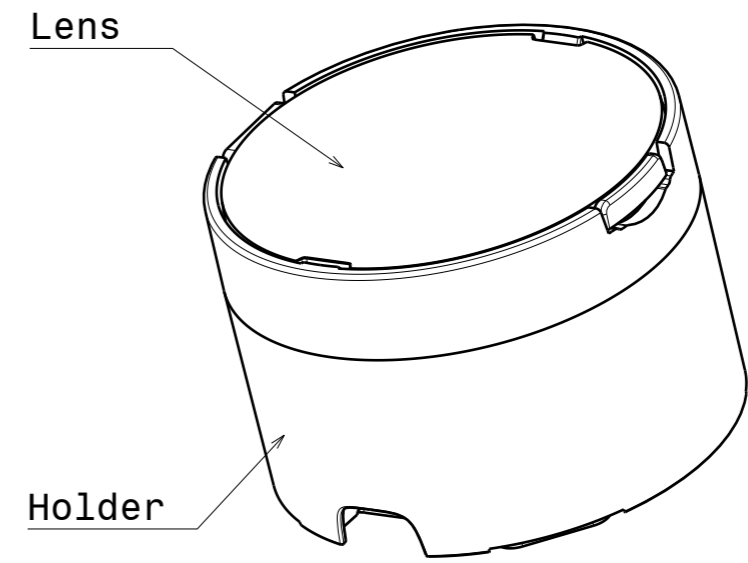

Isometric view
Scale: 3:1

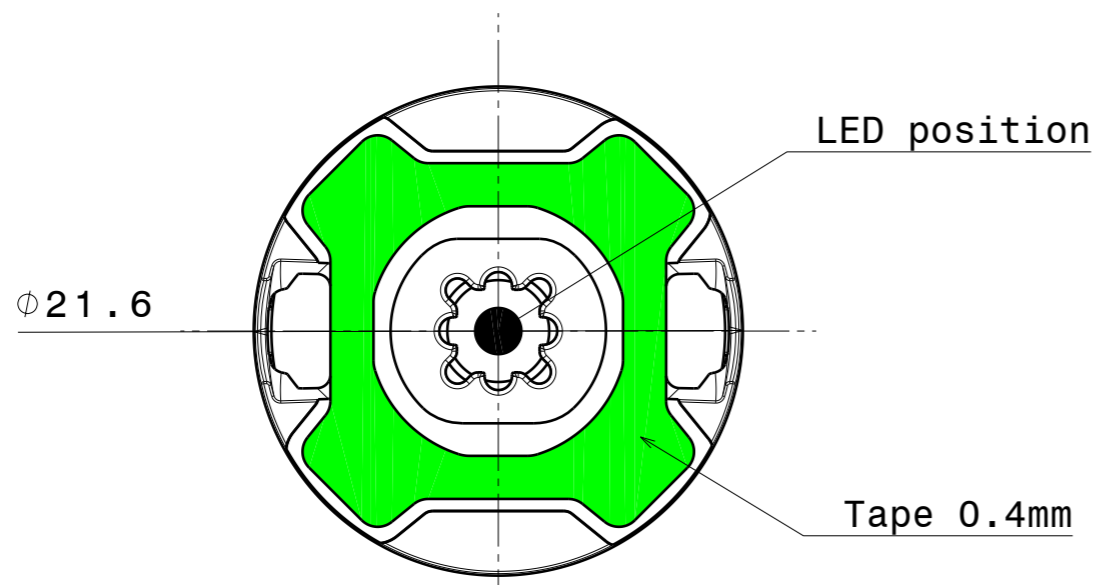

Bottom view
Scale: 3:1

INDEX	DESCRIPTION	MATERIAL	COLOUR
1	Lens	PMMA	
2	Holder	PC	black
3	Tape	PU 2-sided foam tape	adhesive

Tolerances if not otherwise shown
According to DIN ISO 2768-1
Linear measures:
Up to 30mm class M, otherwise class C.
According to DIN ISO 2768-2
Form and position: class L

LEDiL LediL Oy
Salorankatu 10
FIN 24240 SALO
Finland

THIRD ANGLE PROJECTION:

DRAWING TITLE
Datasheet_LXP2-Series

This drawing is the property of LEDiL Oy. It may not be reproduced, copied or communicated without a written agreement with LEDiL Oy.

SIZE **A3** PART NUMBER -

SCALE **3:1** WEIGHT - SHEET **1/1**

Ledil Oy CA11482_LXP2-D CA11482_LXP2-D / LDC (Linear)

Luminaire: Ledil Oy CA11482_LXP2-D CA11482_LXP2-D
Lamps: 1 x Cree XP-G

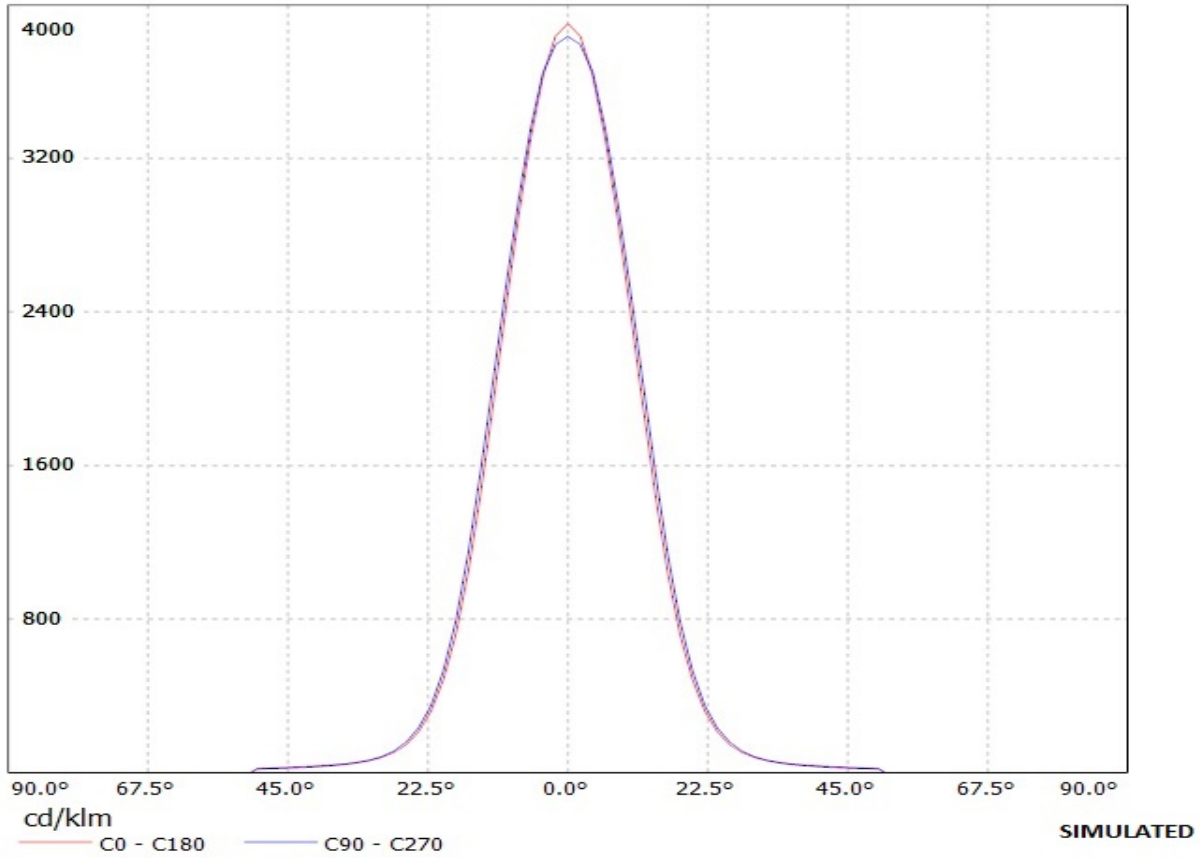

Valaisin: LEDIL OY CA11483_LXP2-M_(XP-G2) Efficiency=90%
Lamput: 1 x Cree XP-G2 (109.1lm @ 250mA)

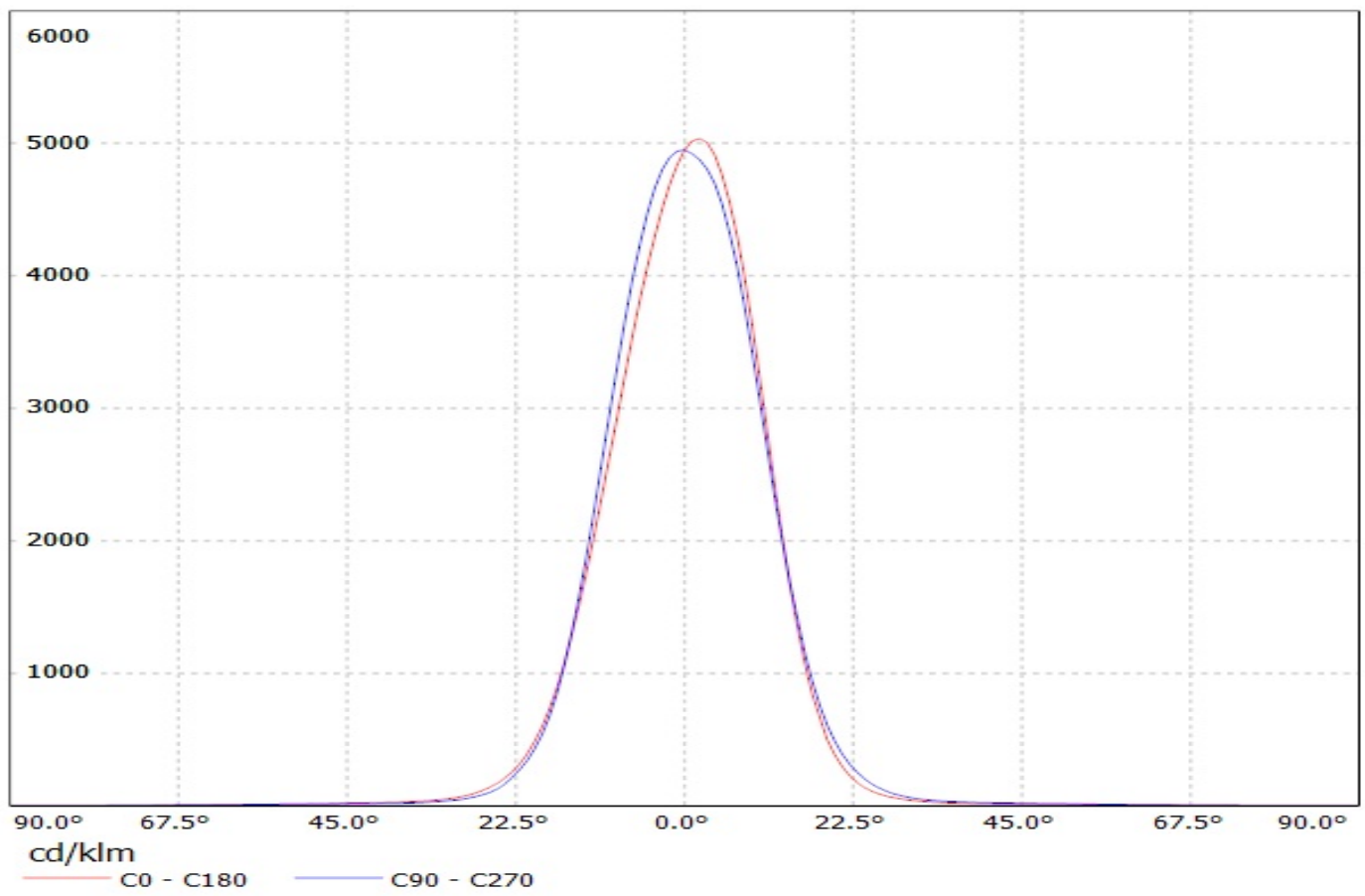

LEDiL Oy CA11483 LXP2-M_(XP-E2) Eff.89.0% / LDC (Linear)

Luminaire: LEDiL Oy CA11483 LXP2-M_(XP-E2) Eff.89.0%

Lamps: 1 x CREE_XP-E2_(XPEBWT-L1-7B4-Q4-0-01)_81.05lm@250mA_P=0.745802W_I=249.9mA

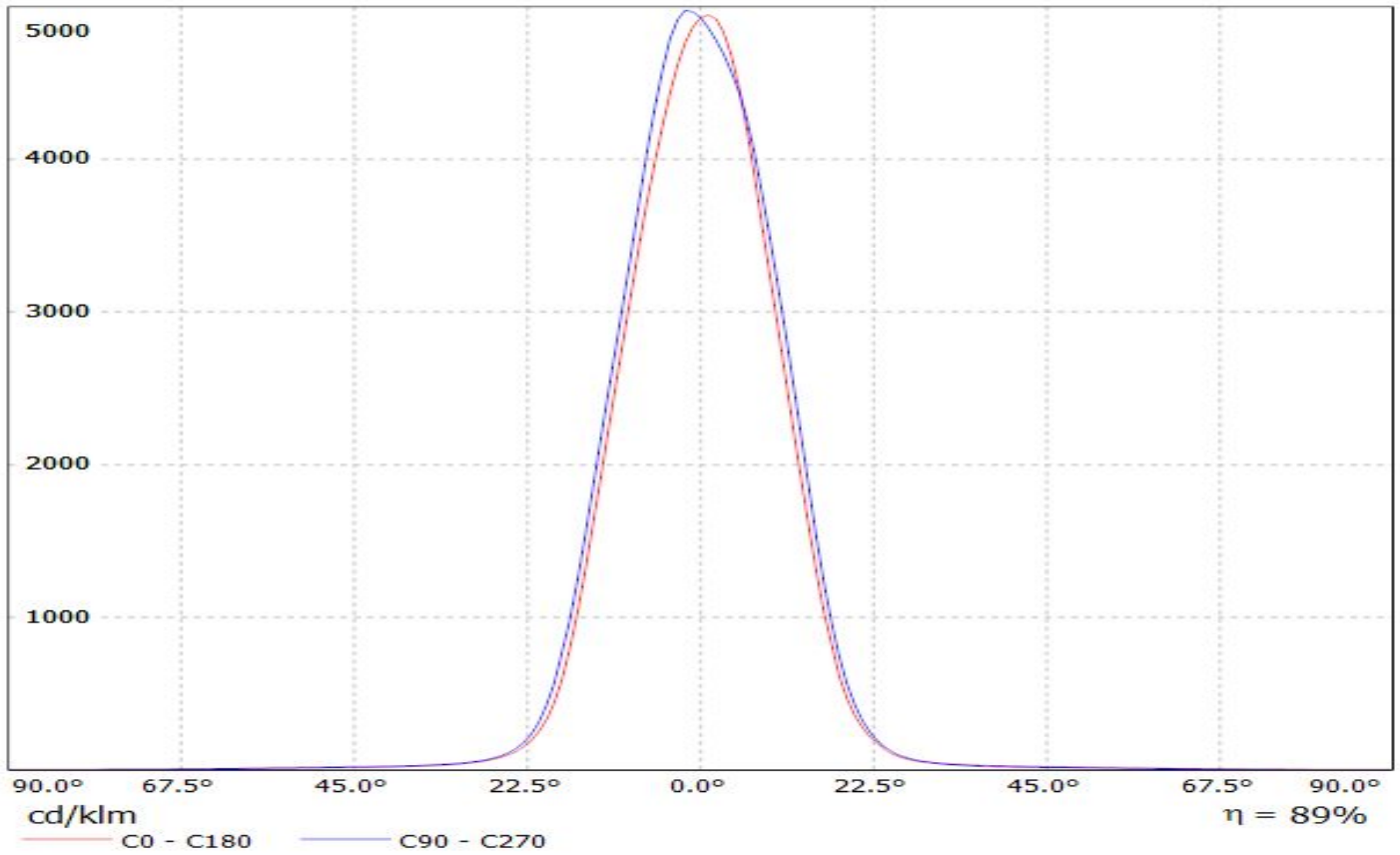

Ledil CA11483_LXP2-M_(XP-L_HI) / LDC (Linear)

Luminaire: Ledil CA11483_LXP2-M_(XP-L_HI)

Lamps: 1 x CREE_XP-L_HI_116.971lm@250mA_P=0.75W_I=0.25A

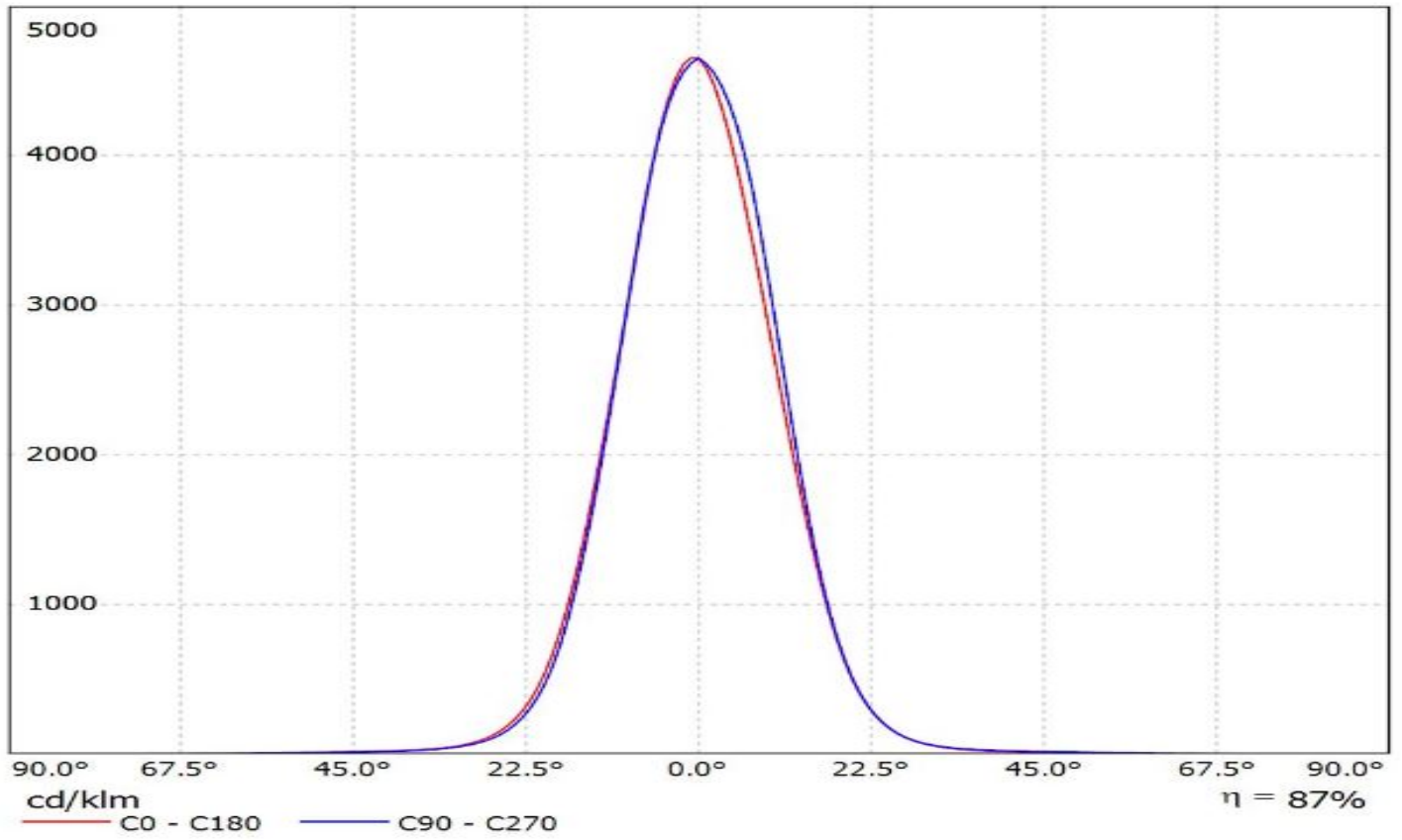

LEDiL Oy CA11483_LXP2-M_(LG3535_2W) Eff.89.6% / LDC (Linear)

Luminaire: LEDiL Oy CA11483_LXP2-M_(LG3535_2W) Eff.89.6%

Lamps: 1 x LG3535_2W (97.3629lm@250mA)

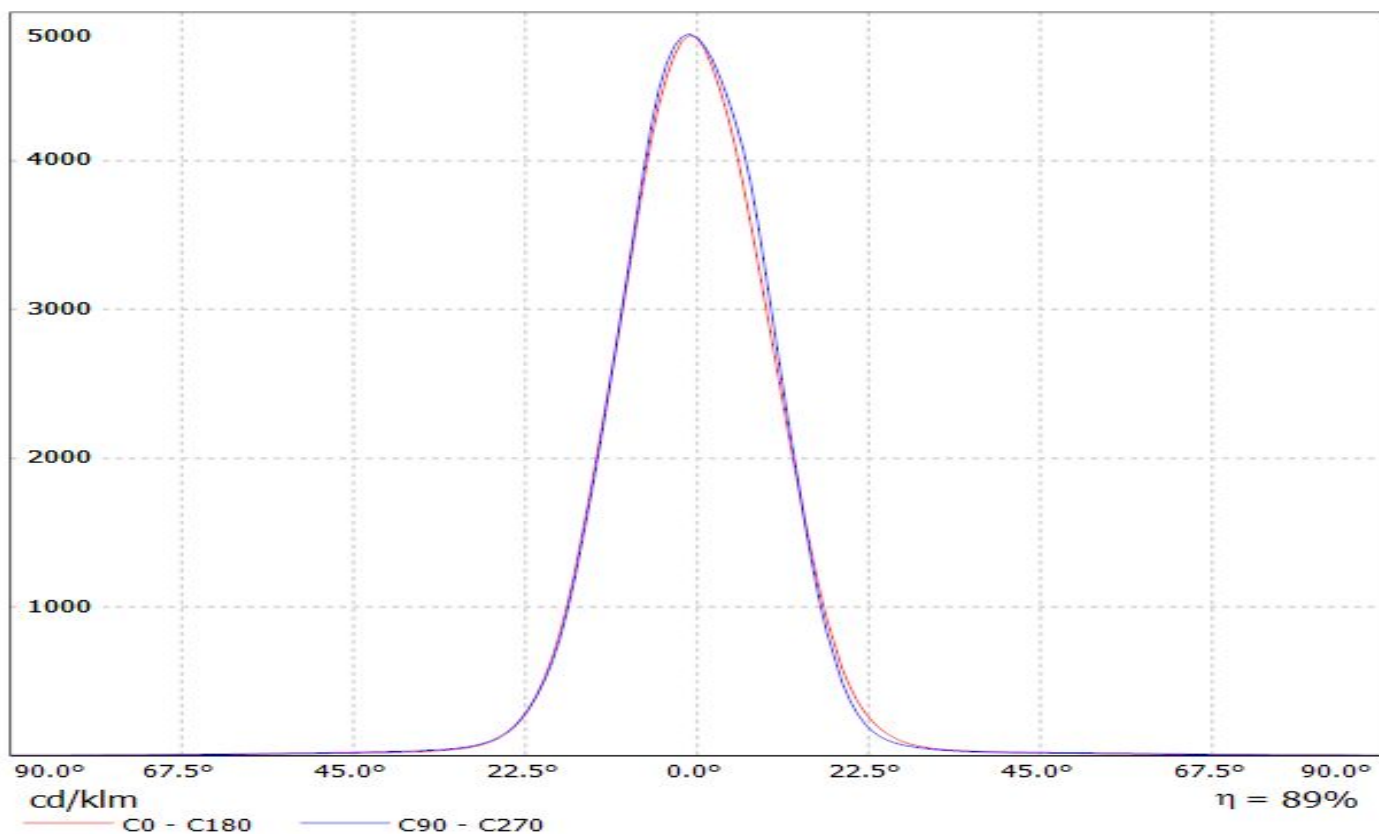

Luminaire: Ledil Oy CA11483_LXP2-M_(3535_Ceramic_gen2) Efficiency=87%
Lamps: 1 x LG 3535 Ceramic gen2 (PKG5700K) 116lm @ 250mA CCT=6200K P=0.7W I=250mA

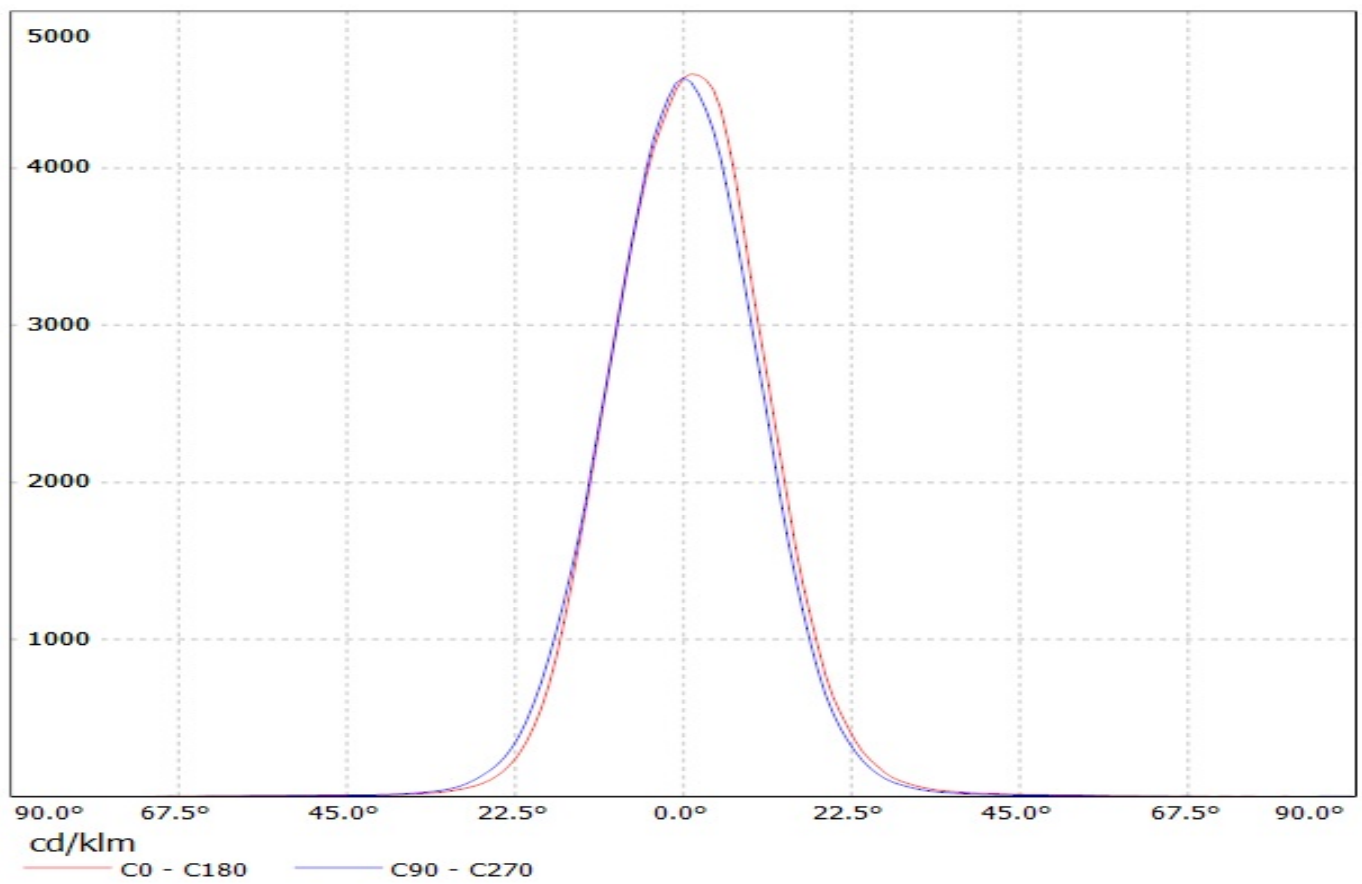

Luminaire: LEDiL Oy CA11483_LXP2-M_(LUXEON_Q) Eff.87.0%
Lamps: 1 x LUXEON_Q_(LHQ-3080)_76.0112lm@250mA_P=0.753249W_I=249.9mA

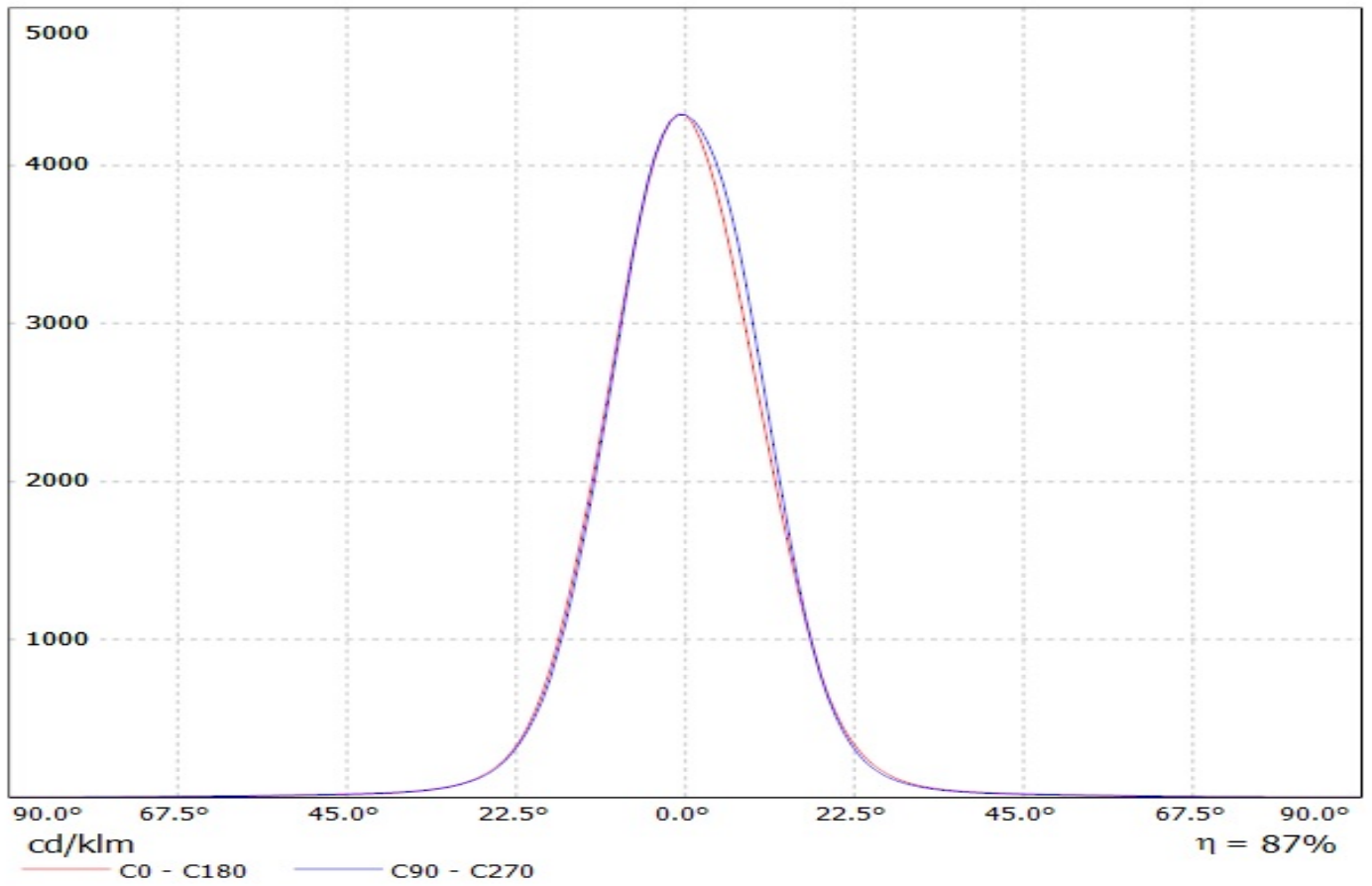

Luminaire: LEDil Oy CA11483_LXP2-M_(Z5M1) Efficiency=87%
Lamps: 1 x Seoul Z5M1 (SZ5M1-W0-C8/W1-A5-G) 108lm @ 250mA CCT=9100K P=0.8W I=250mA

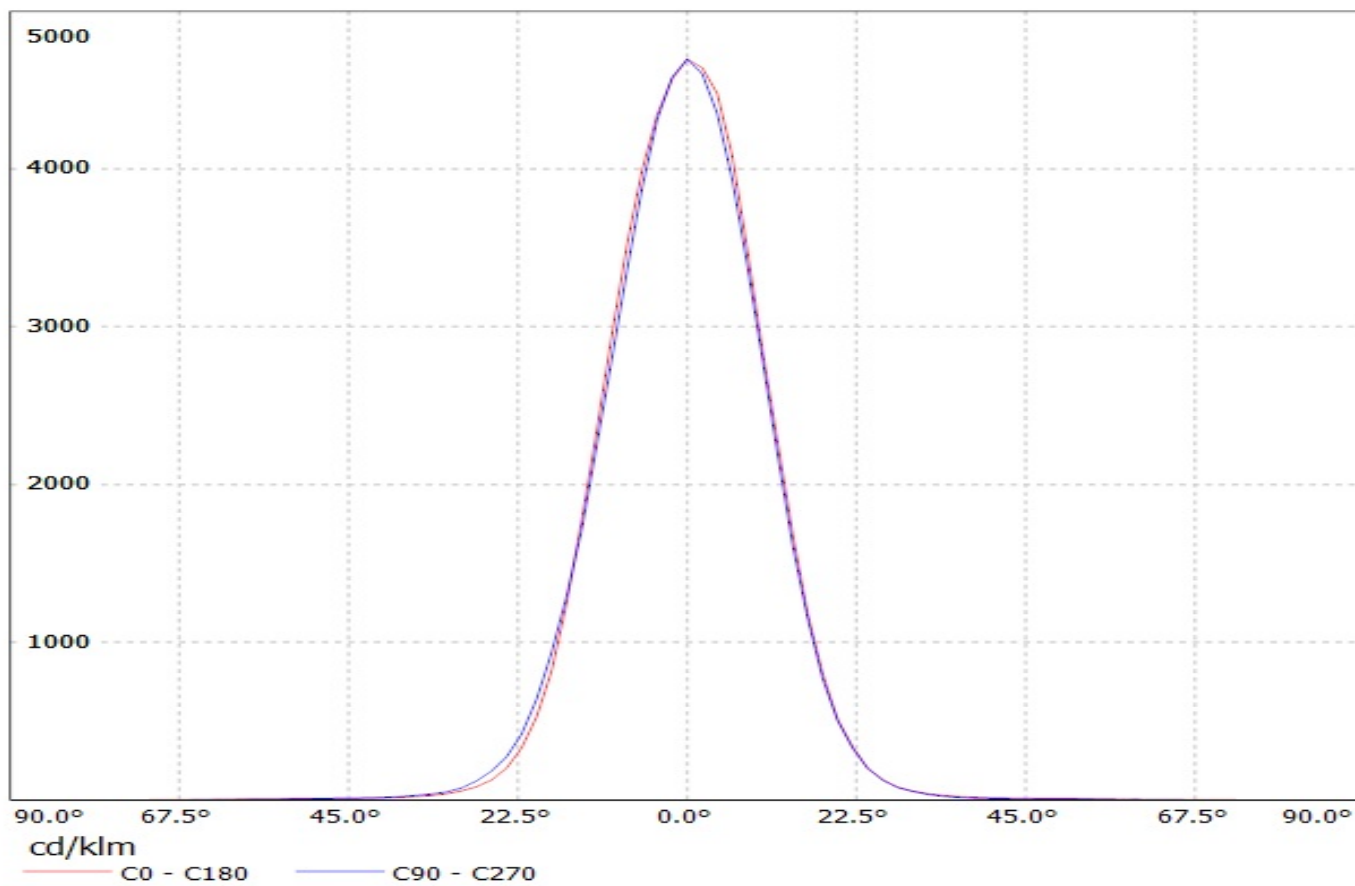

Luminaire: Ledil Oy CA11483_LXP2-M_SEOUL_Z8Y22+_SIMULATED
Lamps: 1 x SEOUL Z8Y22 Plus

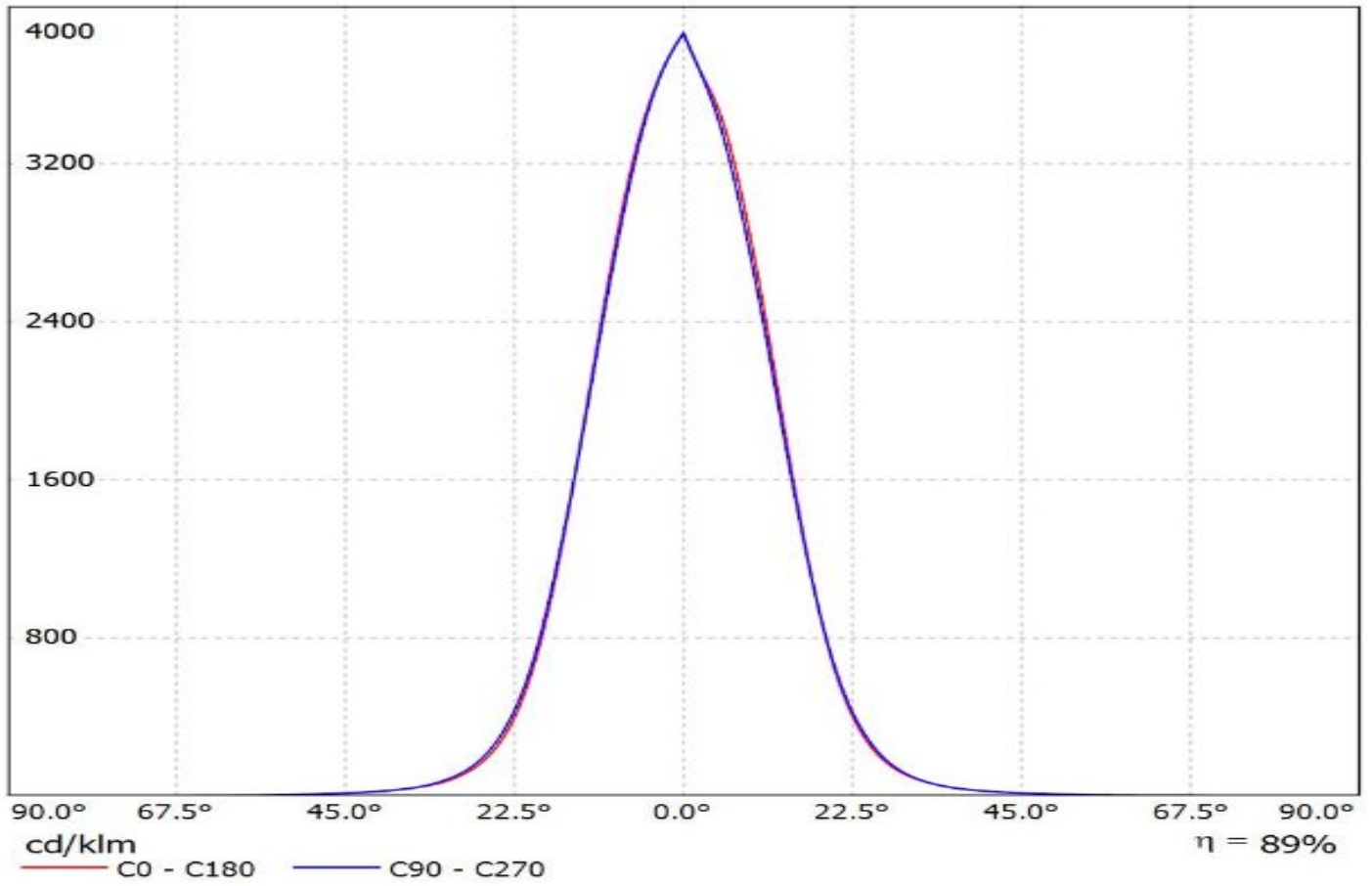

Luminaire: Ledil Oy CA11483_LXP2-M-XT-E (Cree (AWT) XT-E 113lm @ 250mA)
Lamps: 1 x Cree XT-E 113lm @ 250mA

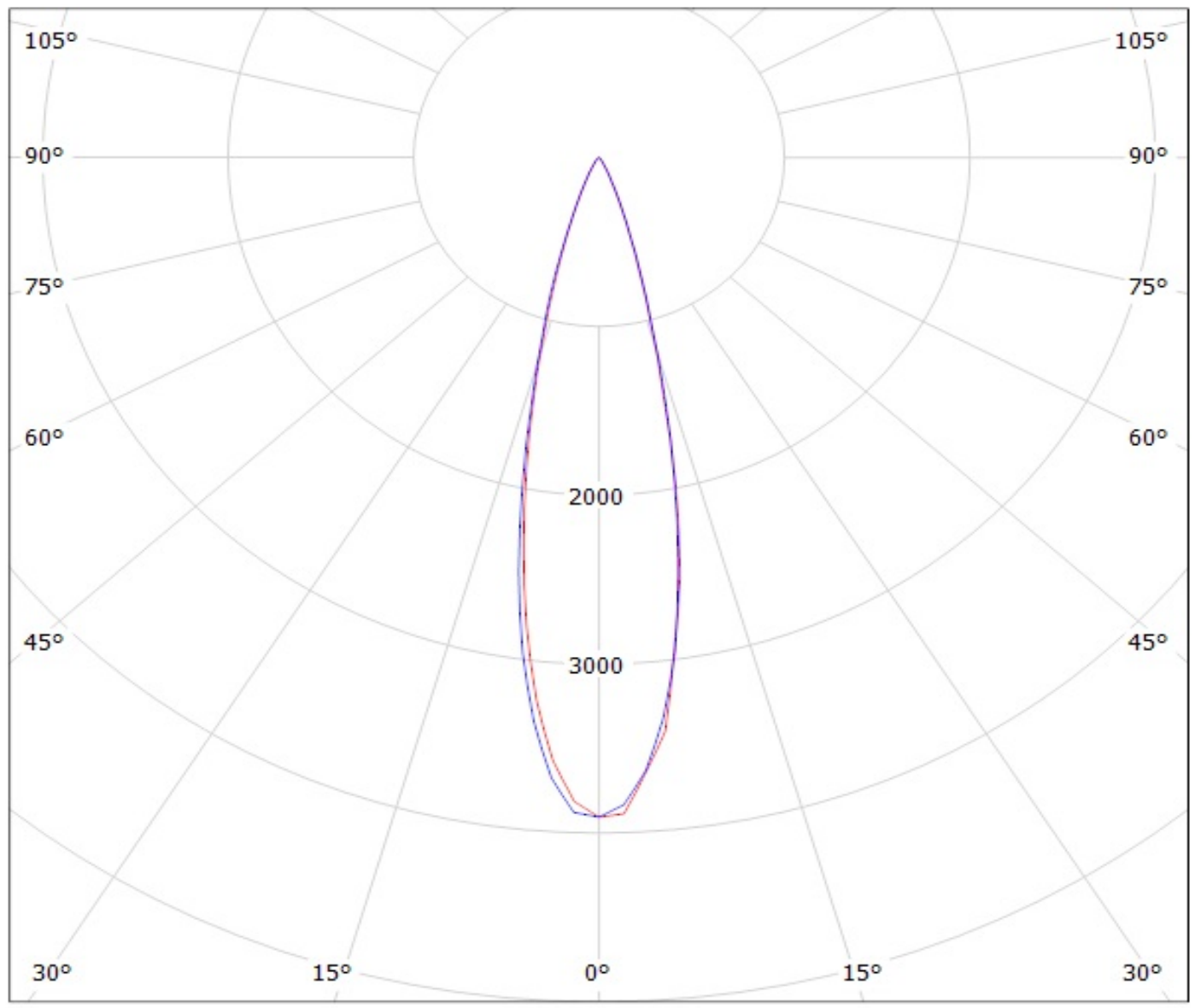

cd/klm
— C0 - C180 — C90 - C270

Ledil Oy CA11482_LXP2-D CA11482_LXP2-D / LDC (Polar)

Luminaire: Ledil Oy CA11482_LXP2-D CA11482_LXP2-D
Lamps: 1 x Cree XP-G

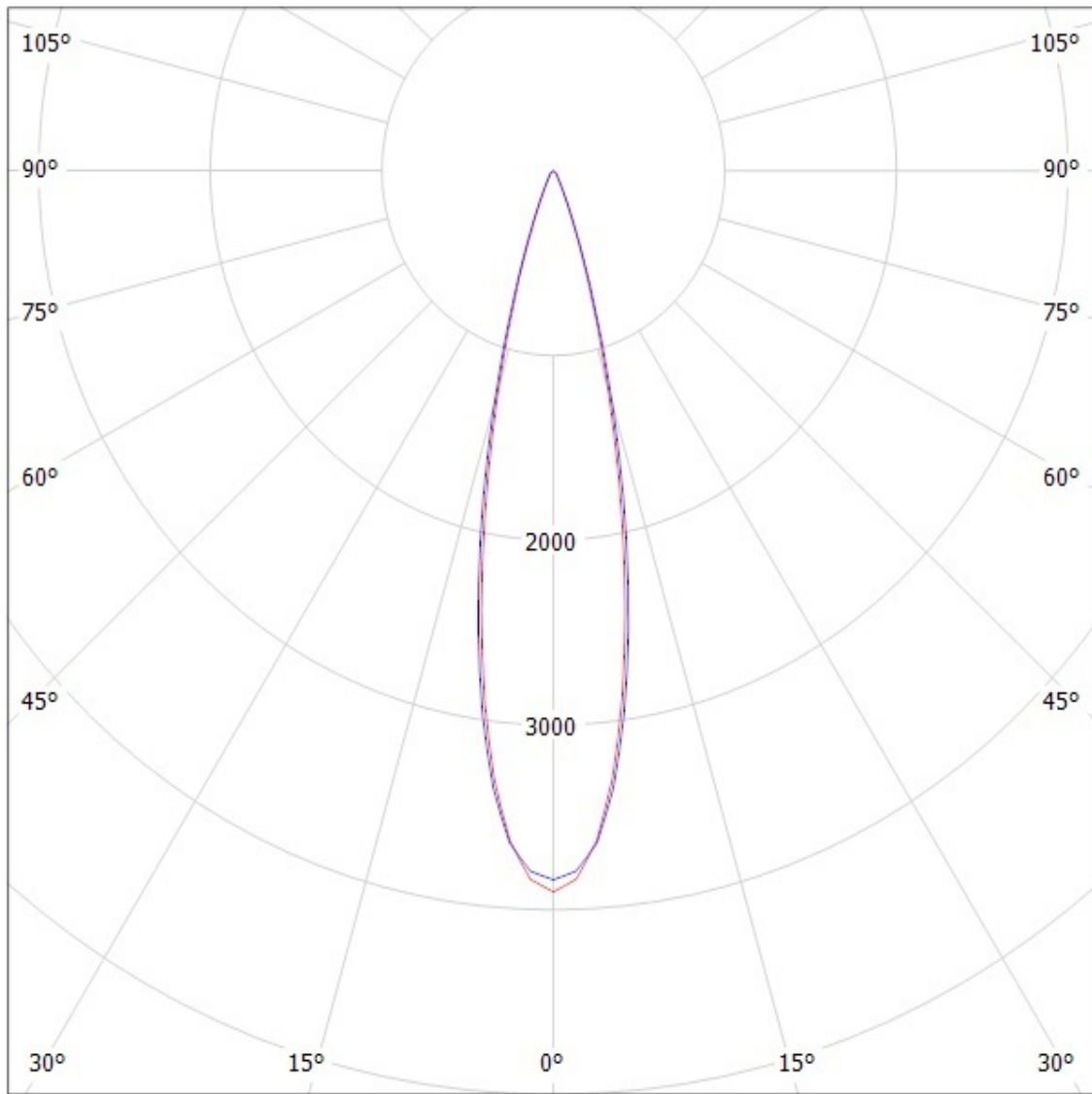

cd/klm

— C0 - C180

— C90 - C270

SIMULATED

Valaisin: LEDIL OY CA11483_LXP2-M_(XP-G2) Efficiency=90%
Lamput: 1 x Cree XP-G2 (109.1lm @ 250mA)

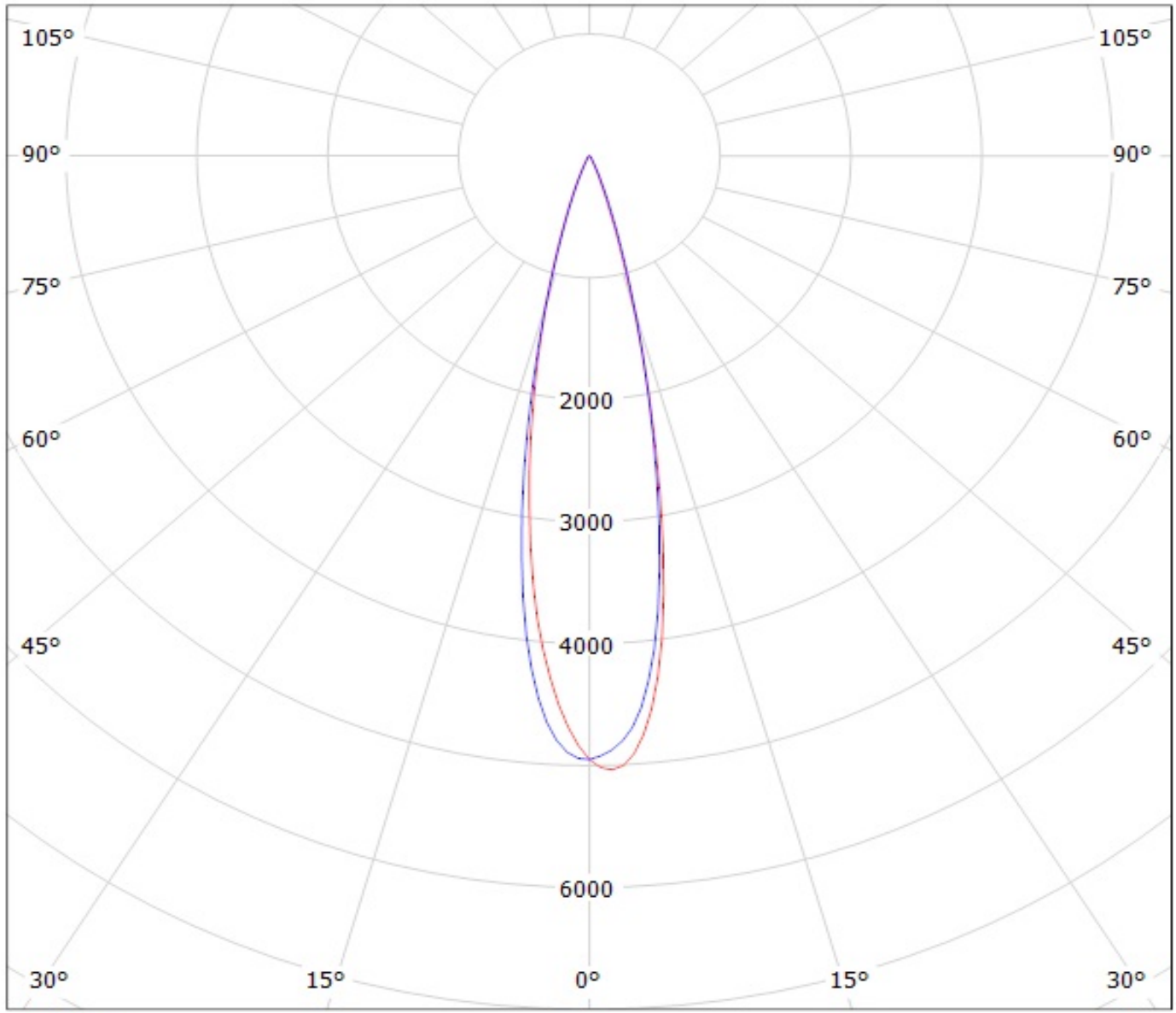

cd/klm

— C0 - C180

— C90 - C270

LEDiL Oy CA11483 LXP2-M_(XP-E2) Eff.89.0% / LDC (Polar)

Luminaire: LEDiL Oy CA11483 LXP2-M_(XP-E2) Eff.89.0%

Lamps: 1 x CREE_XP-E2_(XPEBWT-L1-7B4-Q4-0-01)_81.05lm@250mA_P=0.745802W_I=249.9mA

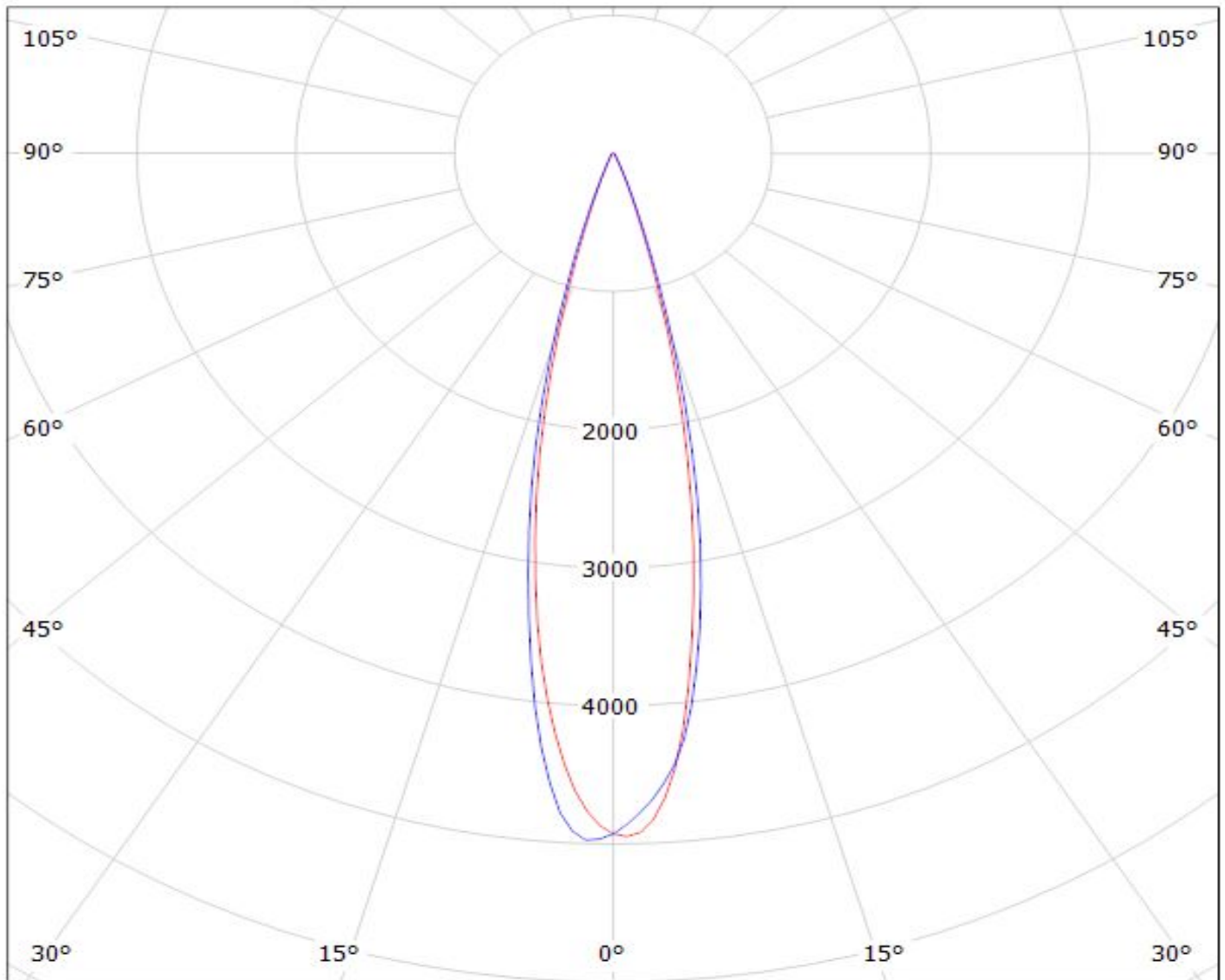

cd/klm

— C0 - C180

— C90 - C270

$\eta = 89\%$

Ledil CA11483_LXP2-M_(XP-L_HI) / LDC (Polar)

Luminaire: Ledil CA11483_LXP2-M_(XP-L_HI)

Lamps: 1 x CREE_XP-L_HI_116.971lm@250mA_P=0.75W_I=0.25A

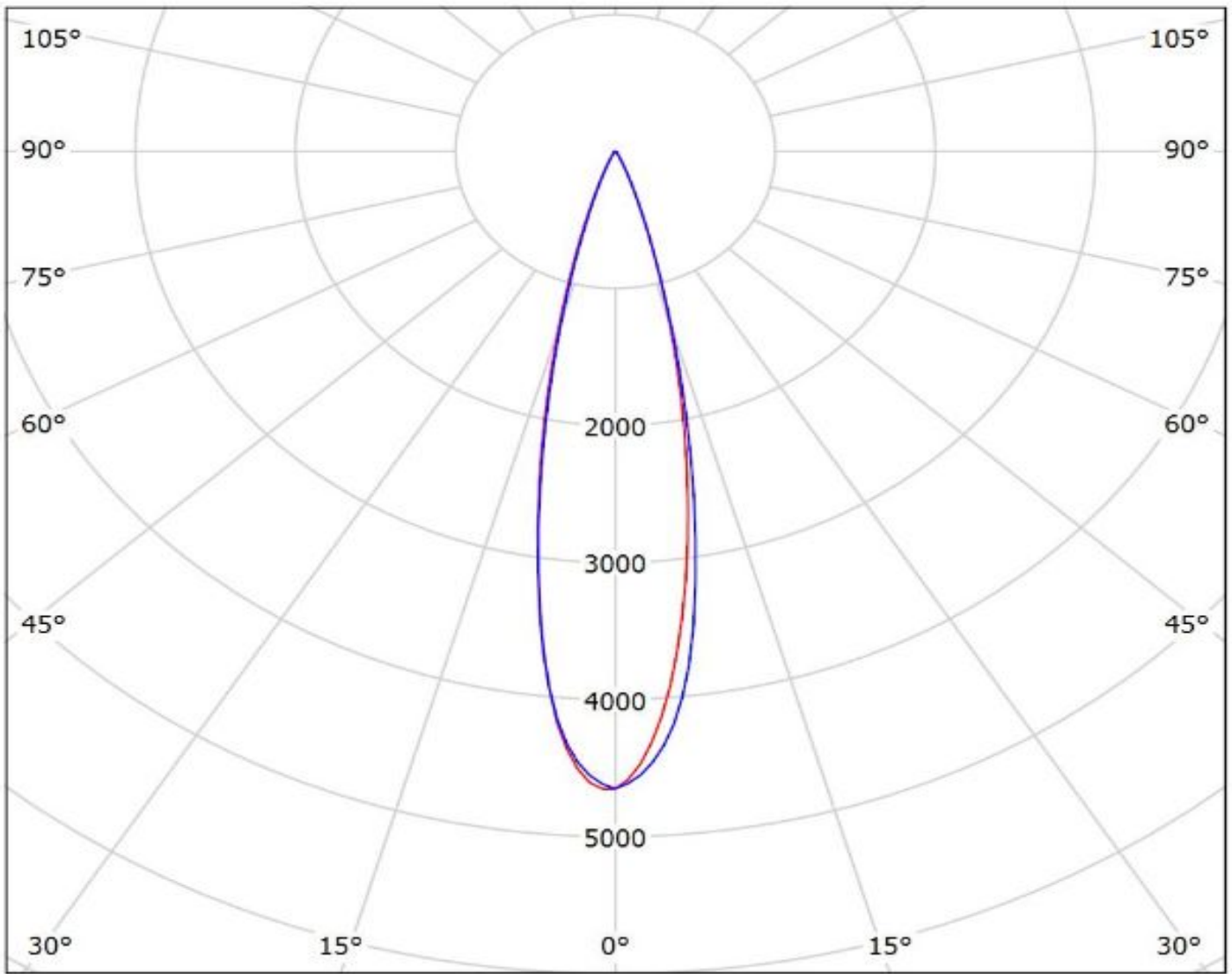

cd/klm

— C0 - C180

— C90 - C270

$\eta = 87\%$

LEDiL Oy CA11483_LXP2-M_(LG3535_2W) Eff.89.6% / LDC (Polar)

Luminaire: LEDiL Oy CA11483_LXP2-M_(LG3535_2W) Eff.89.6%

Lamps: 1 x LG3535_2W (97.3629lm@250mA)

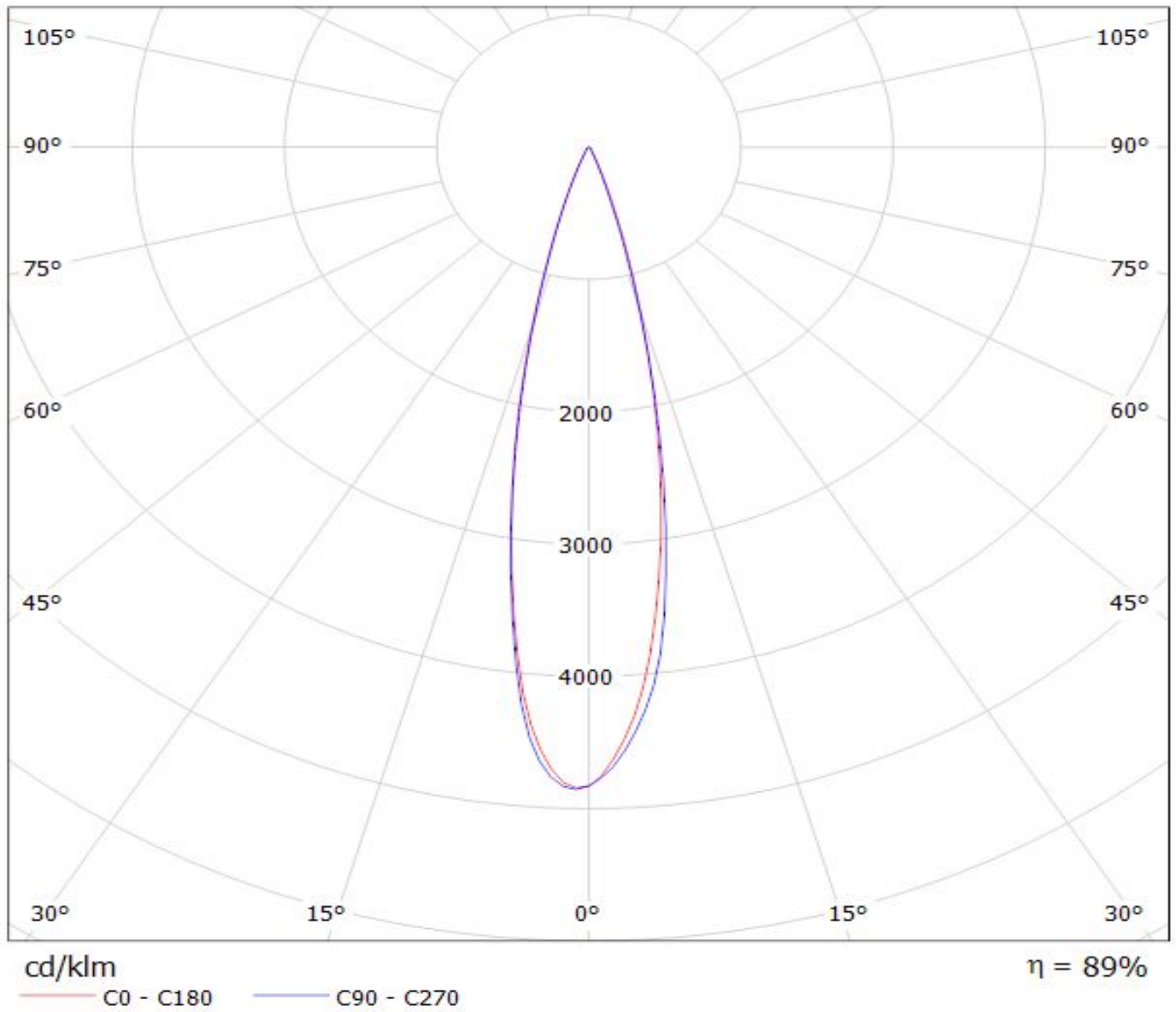

Luminaire: Ledil Oy CA11483_LXP2-M_(3535_Ceramic_gen2) Efficiency=87%
Lamps: 1 x LG 3535 Ceramic gen2 (PKG5700K) 116lm @ 250mA CCT=6200K P=0.7W I=250mA

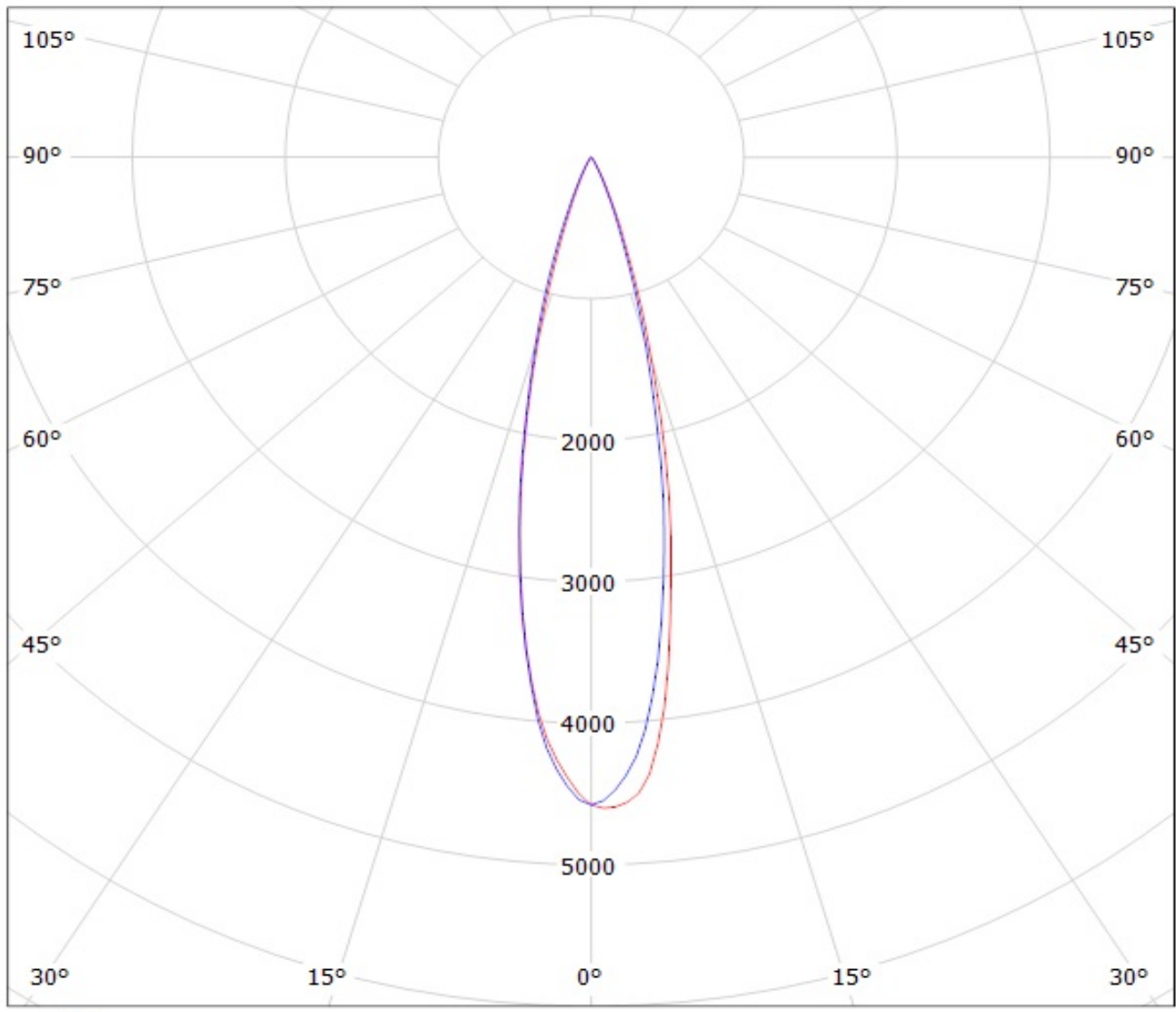

cd/klm
— C0 - C180 — C90 - C270

Luminaire: LEDiL Oy CA11483_LXP2-M_(LUXEON_Q) Eff.87.0%
Lamps: 1 x LUXEON_Q_(LHQ-3080)_76.0112lm@250mA_P=0.753249W_I=249.9mA

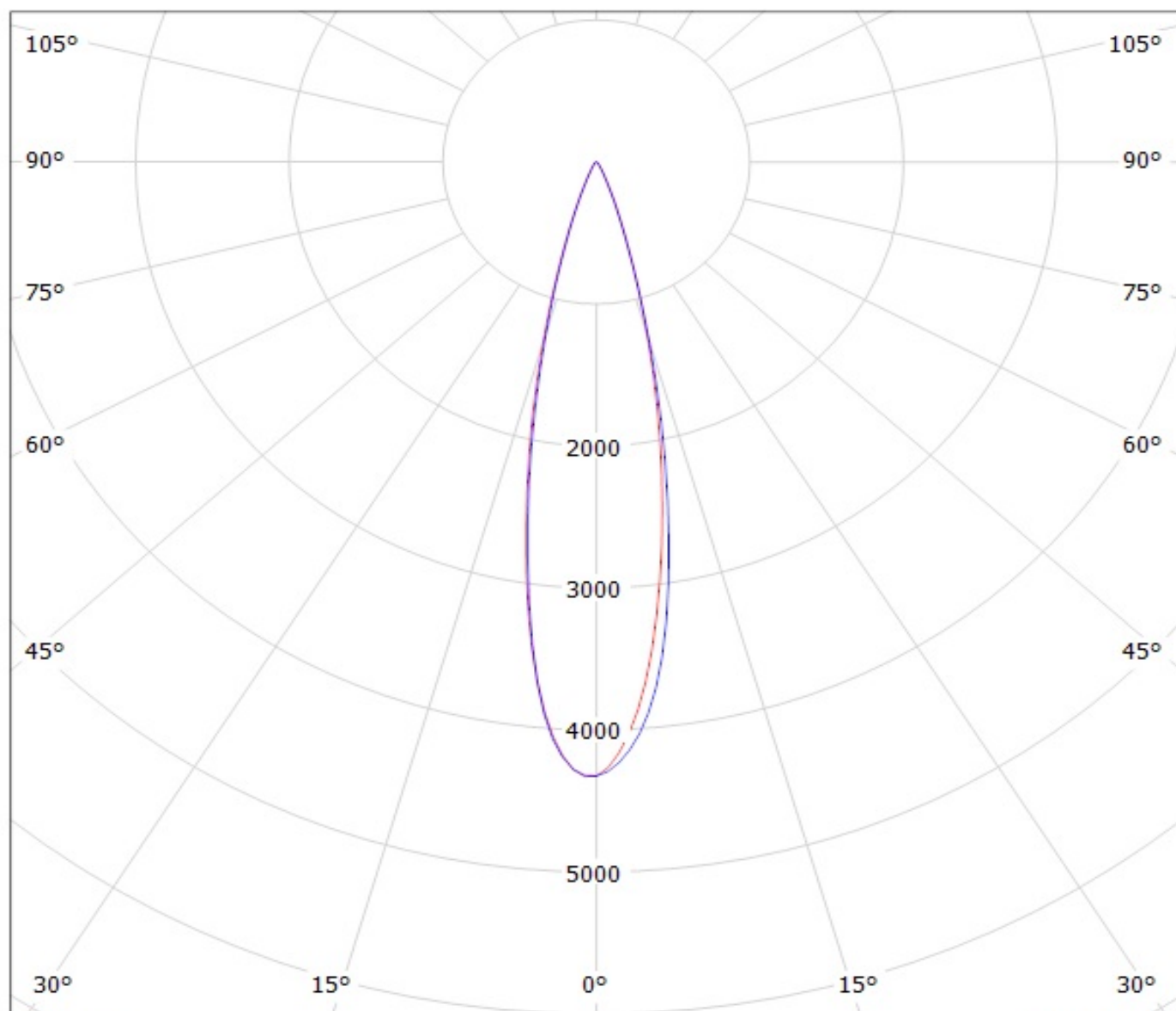

cd/klm

— C0 - C180 — C90 - C270

$\eta = 87\%$

Luminaire: LEDil Oy CA11483_LXP2-M_(Z5M1) Efficiency=87%

Lamps: 1 x Seoul Z5M1 (SZ5M1-W0-C8/W1-A5-G) 108lm @ 250mA CCT=9100K P=0.8W I=250mA

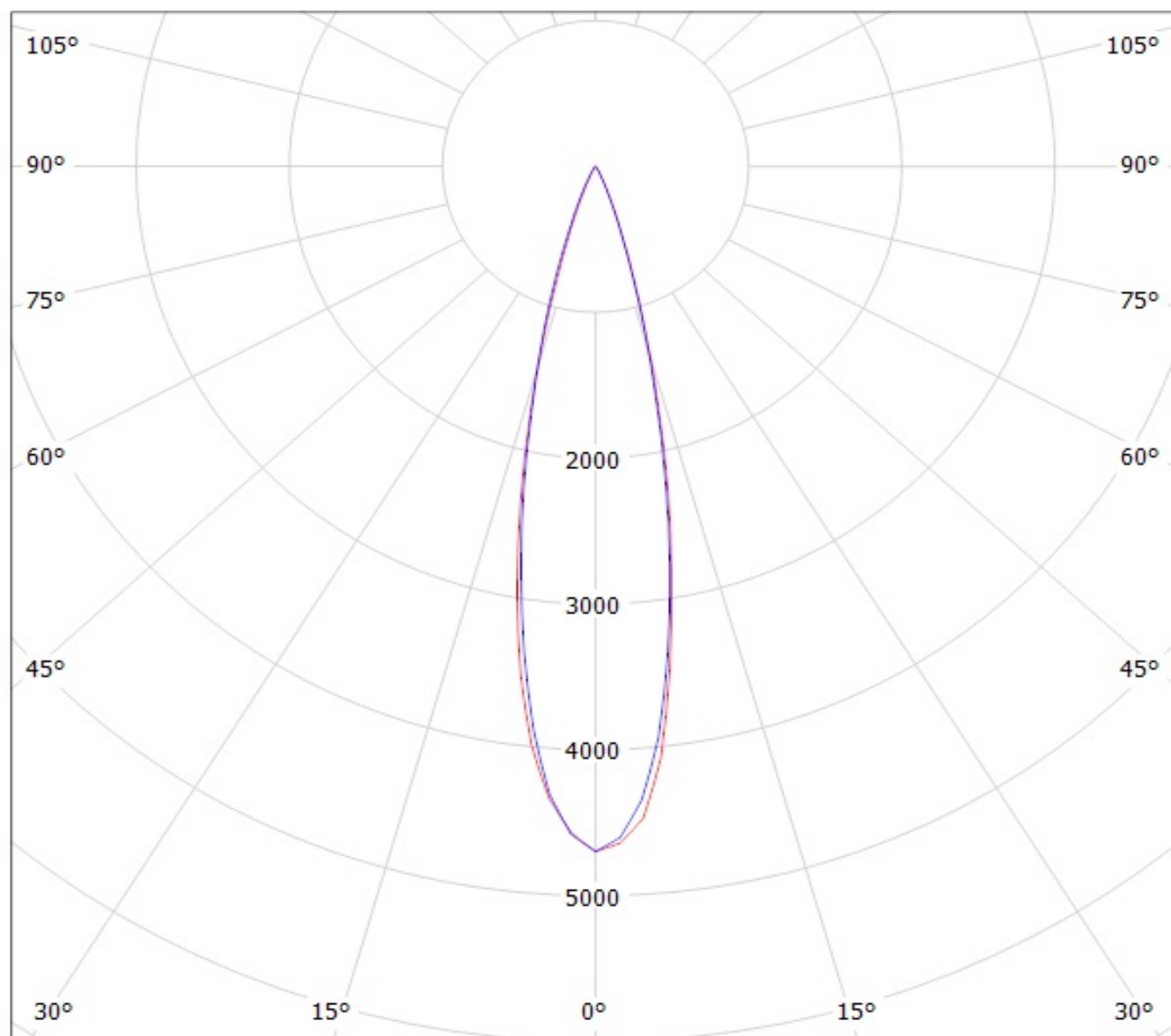

cd/klm

— C0 - C180

— C90 - C270

Luminaire: Ledil Oy CA11483_LXP2-M_SEOUL_Z8Y22+_SIMULATED
Lamps: 1 x SEOUL Z8Y22 Plus

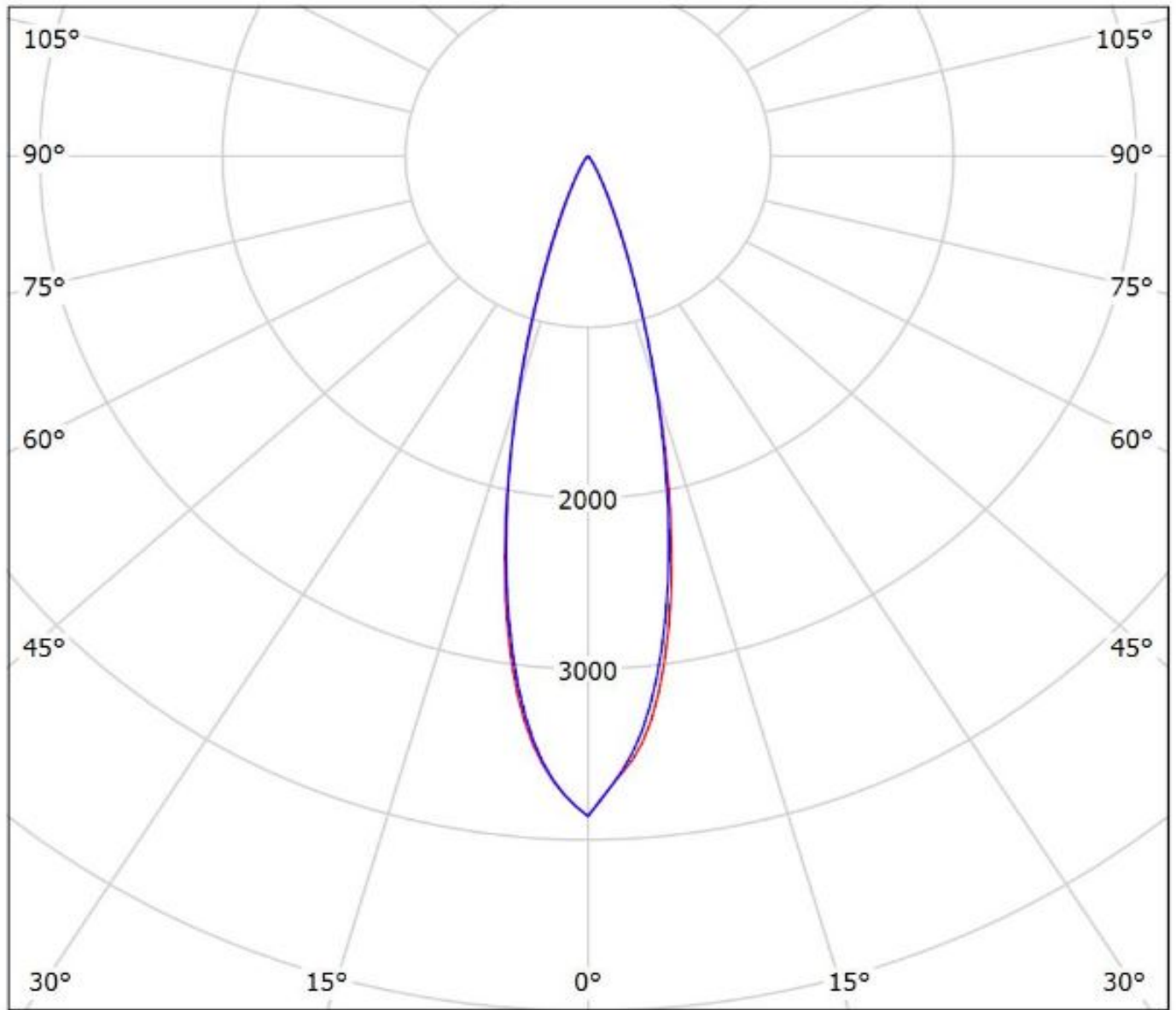

cd/klm
— C0 - C180 — C90 - C270

$\eta = 89\%$

NOTE: The typical divergence will be changed by different color, chip size and chip position tolerance. The typical total divergence is the full angle measured where the luminous intensity is half of the peak value.