

Tous droits strictement réservés. Reproduction ou communication à des tiers interdite sous quelque forme que ce soit sans autorisation écrite du propriétaire. Propriété de c FCI. Droits de reproduction FCI.

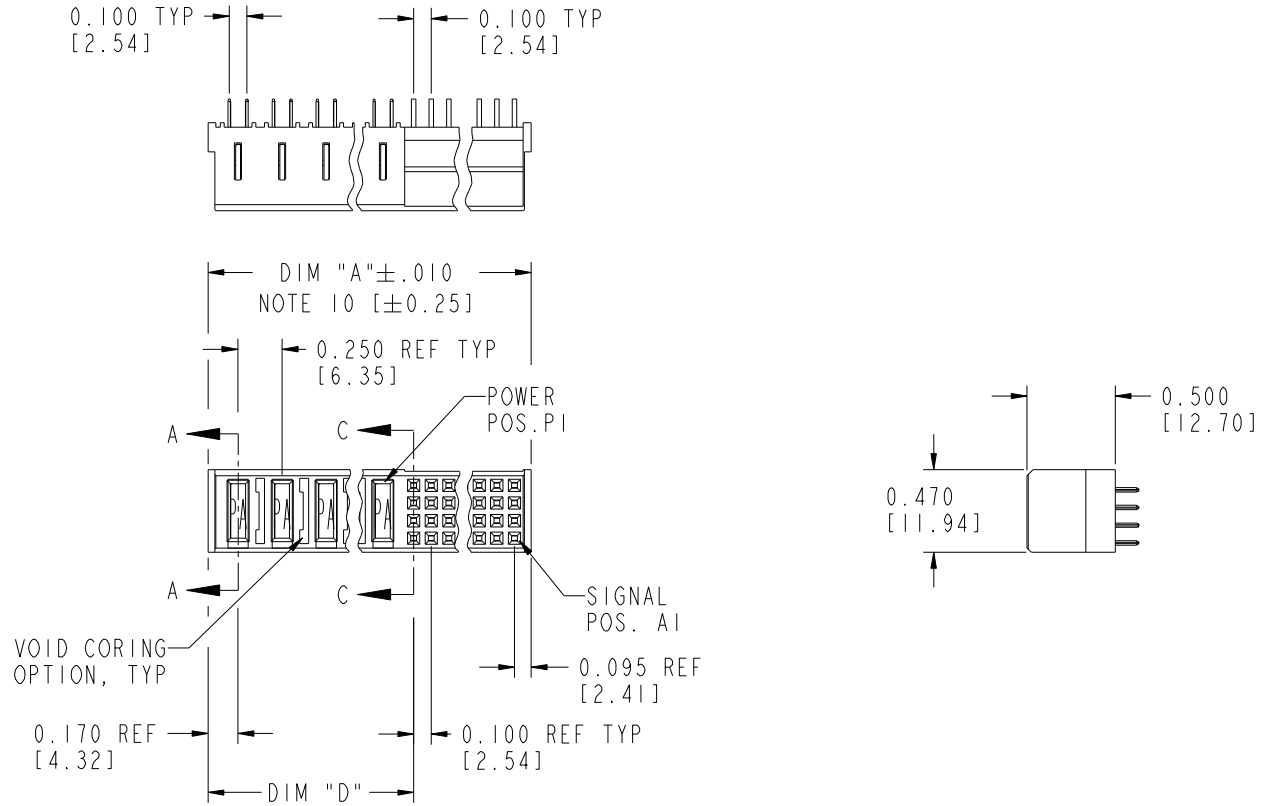

All rights strictly reserved. Reproduction or issue to third parties in any form whatsoever is not permitted without written authority from the proprietor. Property of FCI. Copyright FCI.

PRODUCT NUMBER  
51745-A00CCDDE0...  
SEE NOTE 1



mat'l code				SEE NOTE 2	tolerances unless otherwise specified		CUSTOMER		
ltr	ecn no.	dr	date	linear	.XX±.01/0.X±0.3	projection	COPY		www.fciconnect.com
H	DG05-0471	CS	11/16/05		.XXX±.005/0.XX±0.13			title	
J	DG08-0239	JC	09/11/08	angles	.XXX±.0020/.XX±.051	VERTICAL RECEPTACLE w/o GUIDE PIN SIGNAL / POWER			
					0° ± 2°		product family		PwrBlade
				dr	D. EATON		05-25-99	size	dwg no
				enr	J. BROWN	05-24-99	A	51745	sheet
				chr	J. BROWN	05-25-99			1 OF 3
				appd	J. BROWN	05-25-99	scale		
sheet index		revision sheet		J	J	J	1:1		
		1 2 3							

cage code 22526

Pro/E

Tous droits strictement réservés. Reproduction ou communication à des tiers interdite sous quelque forme que ce soit sans autorisation écrite du propriétaire. Propriété de c.FCI. Droits de reproduction FCI.



All rights strictly reserved. Reproduction or issue to third parties in any form whatever is not permitted without written authority from the proprietor. Property of FCI. Copyright FCI.

PRODUCT NUMBER
51745-A00CCCDDE0..
SEE NOTE 1

1 | 2

3 |

4

DIM	LENGTH FORMULAS (SEE NOTE 10)
DIM "A"	.250 [6.35] x DD + .100 [2.54] x (CCC/4) + .090 [2.29] (NOTE 10)
DIM "D"	.250 [6.35] x DD + .095 [2.41]
DIM "F"	.250 [6.35] x DD + .100 [2.54] x (CCC/4) + .120 [3.05]
DIM "G"	.250 [6.35] x DD - .025 [0.64]

CONNECTOR NOTES

- PRODUCT NUMBER CODE:  
 51745 - A 00 CCC DD E 0 LF



NO THIS SUFFIX: 100u"/2.54um SnPb ON PCB INTERFACE  
 ADD THIS SUFFIX: 78u"/2.00um Sn ON PCB INTERFACE 

ALWAYS '0' (ZERO) (NOTE 8)  
 TAIL OPTIONS (NOTE 7)  
 NUMBER OF LEFT END POWER CONTACTS (NOTE 6)  
 NUMBER OF SIGNAL CONTACTS (NOTE 5)  
 ALWAYS '00' (ZERO, ZERO) (NOTE 4)  
 PLATING (NOTE 3)  
 BASE NUMBER
- HOUSING MATERIAL: GLASS FILLED V-O HIGH TEMP THERMO PLASTIC.  
 SIGNAL CONTACT MATERIAL: COPPER ALLOY  
 POWER CONTACT MATERIAL: COPPER ALLOY
- PLATING OPTION:  
 I = SEE PRINT 10064183 FOR PLATING SPEC OF 51745-100CCCDDE0; 51745-100CCCDDE0LF
- RIGHT END POWER CONTACT, 01 TO 20 AVAILABLE.  
 MAXIMUM OF 20 POWER CONTACTS PER CONNECTOR.
- SIGNAL CONTACTS, 004 TO 148 AVAILABLE.
- THIS PART NOT AVAILABLE WITH RIGHTSIDE POWER CONTACTS.
- TAIL OPTIONS:  
 A = .135±.010 [3.43±.25] SOLDER TO BOARD  
 C = .135±.010 [3.43±.25] PRESS FIT

- BOARD RETENTION NOT AVAILABLE WITH GUIDELESS ENDS.
  - MANUFACTURE'S NAME, P/N, AND DATE CODE TO APPEAR ON THIS SURFACE.
  - THE MAXIMUM OVERALL LENGTH (DIM A) OF A PART IS 8.00 [203.2].
  - PRODUCT SPECIFICATION GS-12-149.
  - REFERENCE 51698 FOR SPECIALS WORKSHEET.
- PCB NOTES:
- ALL DIMENSIONS ARE BASIC UNLESS OTHERWISE SPECIFIED.
  - ALL THROUGH HOLES ARE LOCATED WITH A TRUE POSITION OF .004 [0.01]
  - ALL HOLE DIAMETERS ARE FINISHED HOLE SIZE.
  - 0.0453±.001 [1.151±.02] DRILLED HOLES PLATED WITH 0.0003 [0.007] MIN SnPb OVER 0.001 [1.03] TO .003 [0.08] PLATING TO ACHIEVE A .040 ±.003 [1.02 ±.08] HOLE.
  - A  SYMBOL WILL BE NEXT TO ANY DIMENSION, VIEW, OR NOTE WHICH HAS BEEN MODIFIED WITH THE CURRENT DRAWING REVISION.

A

A

mat'l code SEE NOTE 2				tolerances unless otherwise specified		CUSTOMER		 www.fciconnect.com	
ltr	ecn no.	dr	date	linear	.XX±.01/0.X±0.3	COPY		projection 	title VERTICAL RECEPTACLE w/o GUIDE PIN SIGNAL / POWER
J					.XXX±.005/0.XX±0.13	INCH/MM			
				angles	.XXX±.0020/.XX±.051	scale		product family PwrBlade	code
				dr	0°±2°	1:1		size	213
				enr	D. EATON 05-25-99	A		dwg no	51745
				chr	PROD_ENG: I DATE_ENGR: I			sheet	2
				appd	J. BROWN 05-25-99				
sheet index	revision sheet								

B

B

1 | 2

Pro/E

3 |

cage code 22526

4

Tous droits strictement réservés. Reproduction ou communication à des tiers interdite sous quelque forme que ce soit sans autorisation écrite du propriétaire. Propriété de c.FCI. Droits de reproduction FCI.

All rights strictly reserved. Reproduction or issue to third parties in any form whatever is not permitted without written authority from the proprietor. Property of FCI. Copyright FCI.

PRODUCT NUMBER  
51745-A00CCDDE0..  
SEE NOTE 1

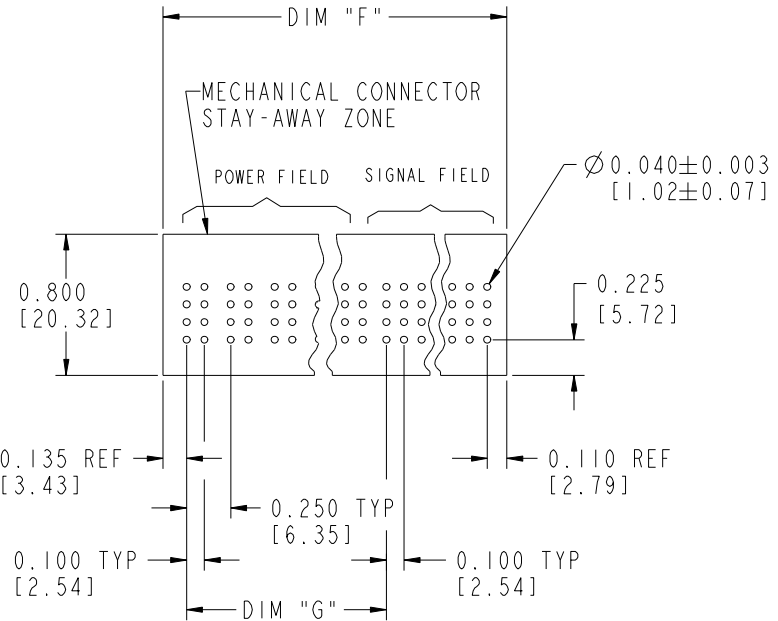
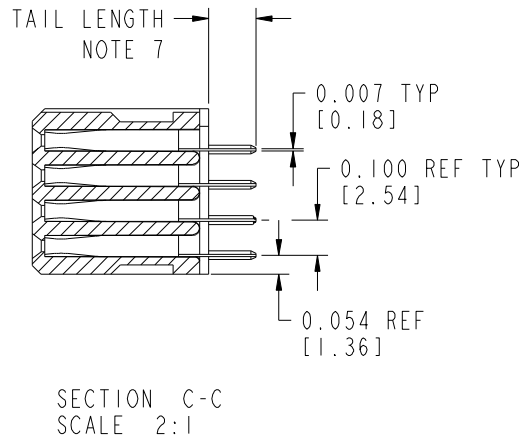
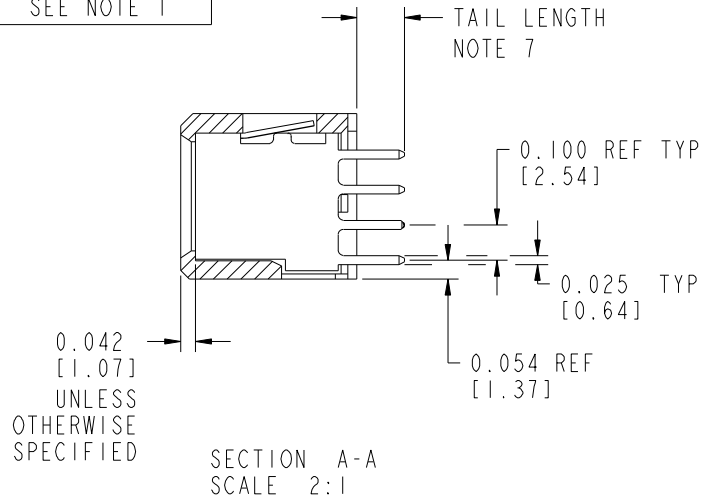

mat'l code		SEE NOTE 2		tolerances unless otherwise specified		CUSTOMER		 www.fciconnect.com	
ltr	ecn no.	dr	date	linear	.XX±.01/0.X±0.3	COPY		title	
J					.XXX±.005/0.XX±0.13	projection		VERTICAL RECEPTACLE w/o GUIDE PIN SIGNAL / POWER	
				angles	.XXX±.0020/.XX±.051			product family	
				dr	0°±2°	INCH/MM		PwrBlade	
				enr	D. EATON 05-25-99	scale		code	
				chr	J. BROWN 05-24-99	1:1		213	
				appd	J. BROWN 05-25-99	A		sheet	
sheet index		revision sheet						3	
								3	

cage code 22526

Pro/E