



MIC28512 Evaluation Board

70V/2A Synchronous Buck Regulator

General Description

Micrel's MIC28512 is a synchronous step-down regulator featuring unique adaptive on-time control architecture with integrated power MOSFETs. The MIC28512 operates over an input supply range of 4.6V to 70V, and can be used to supply up to 2A of output current. The output voltage is adjustable down to 0.8V with a guaranteed accuracy of $\pm 1\%$ from 0°C to 85°C. The device operates with a programmable switching frequency from 200kHz to 680kHz (nominal).

The MIC28512-1 uses the HyperLight Load[®] architecture to operate in pulse-skipping mode at light load while functioning in fixed-frequency CCM mode from medium load to heavy load. The MIC28512-2 utilizes Hyper Speed Control[™] architecture, operating in fixed-frequency CCM mode under all load conditions.

Datasheets and support documentation are available on Micrel's web site at: www.micrel.com.

Requirements

The MIC28512 evaluation board requires only a single power supply with at least 5A current capability. For applications where V_{IN} is less than +5.5V, the internal LDO can be bypassed by tying VDD to VIN.

Precautions

The MIC28512 evaluation board does not have reverse polarity protection. Applying a negative voltage to the VIN and GND terminals can damage the device. The maximum V_{IN} of the board is rated at 70V; exceeding 70V can damage the device.

Ordering Information

Part Number	Description
MIC28512-1YML EV	MIC28512 Evaluation Board
MIC28512-2YML EV	

Evaluation Board

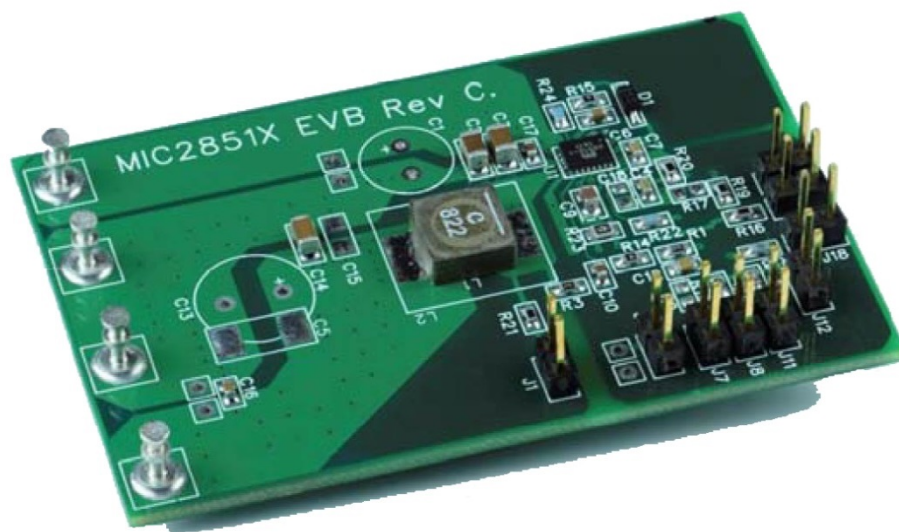

Hyper Speed Control is a trademark and HyperLight Load is a registered trademark of Micrel, Inc.

Micrel Inc. • 2180 Fortune Drive • San Jose, CA 95131 • USA • tel +1 (408) 944-0800 • fax +1 (408) 474-1000 • <http://www.micrel.com>

April 9, 2015

Revision 1.0

Getting Started

1. Connect VIN Supply

Connect a supply to the VIN and GND terminals, paying careful attention to the polarity and the supply range ($4.6V < V_{IN} < 70V$). Monitor I_{IN} with a current meter and monitor input voltage at VIN and GND terminals with a voltmeter. Do not apply power until Step 4.

2. Connect Load and Monitor Input

Connect a load to the VOUT and GND terminals. The load can be either a passive or an active electronic load. A current meter can be placed between the VOUT terminal and load to monitor the output current. Ensure the output voltage is monitored at the VOUT terminal.

3. Enable Input

The EN terminal has an on board 100k Ω pull-up resistor (R16) to VIN, which allows the output to be turned on when PVDD exceeds its UVLO threshold. An EN (J16) connector is provided on the evaluation board for ease-of-access to the enable feature. Applying an external logic signal on the EN terminal to pull it low or using a jumper to short the EN terminal to the GND terminal will disable the MIC28512 evaluation board.

4. Apply Power

Apply V_{IN} and verify that the output voltage regulates to the set voltage.

Evaluation Board Description

The basic parameters of the evaluation board are:

- Input range: 4.6V to 70V
- Output range: 0.8V to $0.85V \times V_{IN}$ at 2A.
(For more detailed information, refer to [Typical Characteristics](#) section. Note that 0.85V is the maximum duty cycle of the MIC28512 controller)
- 300kHz switching frequency
(Adjustable 200kHz to 680kHz)

Feedback Resistors

With Jumper J11 in place, the output voltage is set to 5.0V as determined by the feedback dividers R1 and R11. Jumper J8 sets the output voltage to 3.3V. With jumper J7 in place the output is set by modifying R9, as illustrated in Equation 1:

$$V_{OUT} = V_{REF} \times \left(1 + \frac{R1}{R9}\right) \quad \text{Eq. 1}$$

Where:

$V_{REF} = 0.8V$, and R1 is 10.0k Ω .

With jumpers J11, J8, and J7 removed, the output regulates at the 0.8V reference voltage. All other voltages not listed can be set by modifying R9 with Jumper J7 installed according to Equation 2:

$$R9 = \frac{R1 \times V_{REF}}{V_{OUT} - V_{REF}} \quad \text{Eq. 2}$$

Jumper J12 shorts out the feedback and forces the converter to operate open loop and approach 100% duty cycle.

SW Node

Use test point J1 (V_{SW}) for monitoring the power MOSFET switching waveform.

Current Limit

The MIC28512 uses the $R_{DS(ON)}$ and external resistor connected from ILIM to the SW node to decide the current limit (see [Figure 1](#)).

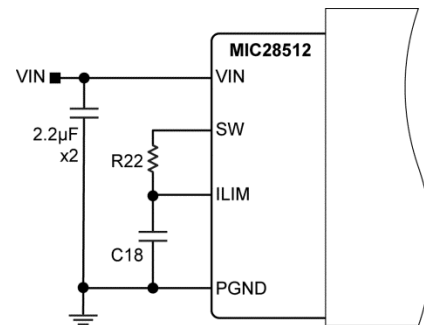

Figure 1. MIC28512 Current-Limiting Circuit

In each switching cycle of the MIC28512 converter the inductor current is sensed by monitoring the low-side MOSFET in the OFF period. The sensed voltage $V_{(ILIM)}$ is compared with the power ground (PGND) after a blanking time of 150ns. In this way, the drop voltage over the resistor R22 (V_{CL}) is compared with the drop over the bottom FET generating the short current limit. The small capacitor (C18) connected from ILIM to PGND filters the switching node ringing during the off time which allows a better short-limit measurement. The time constant created by R22 and C18 should be much less than the minimum off time.

The V_{CL} drop allows programming of short limit through the value of the resistor (R22). If the absolute value of the voltage drop on the bottom FET is greater than V_{CL} , $V_{(ILIM)}$ is lower than PGND and a short-circuit event is triggered.

A “hiccup” soft-start cycle is generated, reducing the stress on the power switching FETs while protecting the load and supply during severe short conditions.

The short circuit current limit can be programmed by using Equation 3:

$$R22 = \frac{(I_{CLIM} - \Delta I_{L(PP)} \times 0.5) \times R_{DS(ON)} + V_{CL}}{I_{CL}} \quad \text{Eq. 3}$$

Where:

I_{CLIM} = Desired current limit

$R_{DS(ON)}$ = On-resistance of low-side power MOSFET, 28mΩ typically

V_{CL} = Current-limit threshold (typical absolute value is 14mV, per the *Electrical Characteristics* section in the MIC28512 datasheet)

I_{CL} = Current-limit source current (typical value is 70μA, per the *Electrical Characteristics* section in the MIC28512 datasheet).

$\Delta I_{L(PP)}$ = Inductor current peak-to-peak

The peak-to-peak inductor current ripple is:

$$\Delta I_{L(PP)} = \frac{V_{OUT} \times (V_{IN(MAX)} - V_{OUT})}{V_{IN(MAX)} \times f_{sw} \times L} \quad \text{Eq. 4}$$

In case of hard short, the short current-limit threshold (V_{CL}) is reduced by half to the short-circuit threshold. This allows an indefinite hard short on the output without any destructive effect. It is critical to make sure that the inductor current used to charge the output capacitance during soft start is below the foldback short-circuit level; otherwise the supply can go into hiccup mode and latch up at start up. This should be verified over the operating temperature range as well.

The MOSFET $R_{DS(ON)}$ varies 30% to 40% with temperature. Therefore, it is recommended to add a 50% margin to I_{CL} in Equation 4 to avoid false current limiting due to increased MOSFET junction temperature rise. [Table 1](#) shows typical output current limit value for a given R22.

Table 1. R22 Typical Output Current-Limit Value

R22	Typical Output Current Limit ($V_{IN} = 12V, V_{OUT} = 5V, L = 8.2\mu H$)
2.21kΩ	4.3A
1.82kΩ	3.0A

The MIC28512 evaluation board was designed with a 8.2μH inductor for operation at 300kHz at 5V output. The typical value of $R_{WINDING(DCR)}$ of this particular inductor is 44mΩ.

Setting the Switching Frequency

The MIC28512 switching frequency can be adjusted by changing the value of resistor R17. The top resistor (R19) is set at 100kΩ and is connected between VIN and FREQ. R4 is connected from the FREQ input to PGND and sets the switching frequency according to Equation 4.

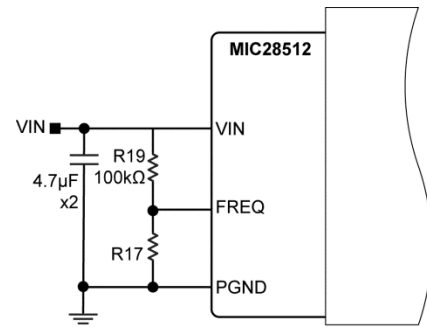

Figure 2. Switching Frequency Adjustment

$$f_{sw_ADJ} = f_O \times \frac{R17}{R19 + R17} \quad \text{Eq. 4}$$

Where:

f_O = Switching frequency when R17 is open, per the *Electrical Characteristics* section in the MIC28512 datasheet.

For a more precise setting, it is recommended to use the [Figure 3](#):

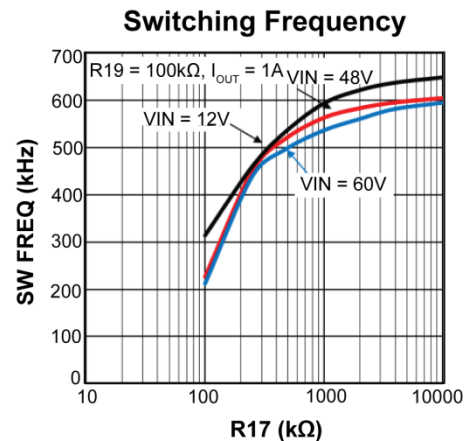
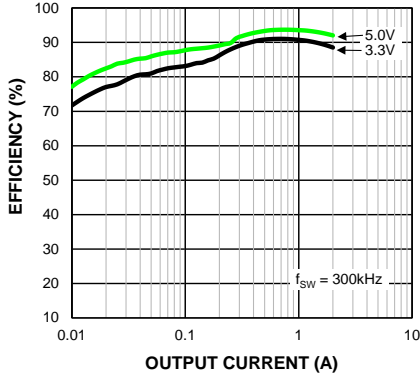

Figure 3. Switching Frequency vs. R17

Typical Characteristics

**Efficiency (VIN = 12V)
vs. Output Current MIC28512-1**



**Efficiency (VIN = 24V)
vs. Output Current MIC28512-1**

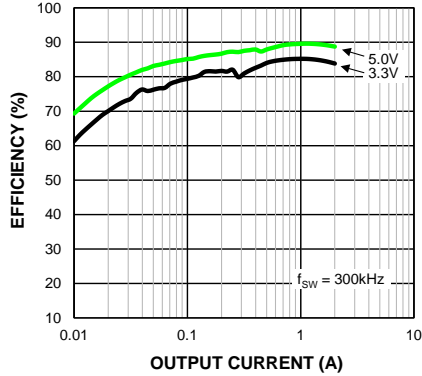

**Efficiency (VIN = 48V)
vs. Output Current MIC28512-1**

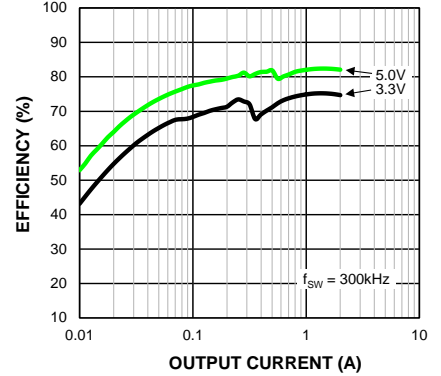

**12V Input Thermal Derating
MIC28512-1**

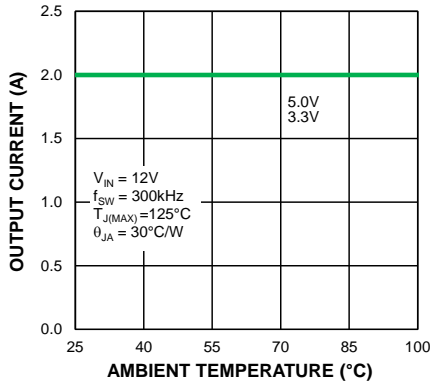

**24V Input Thermal Derating
MIC28512-1**

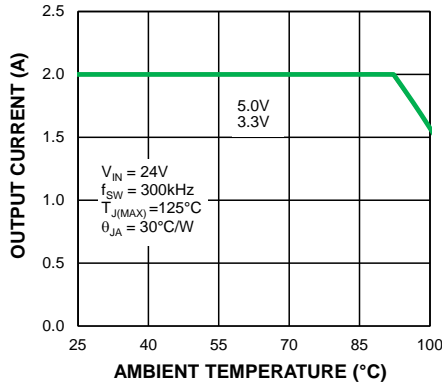

**48V Input Thermal Derating
MIC28512-1**

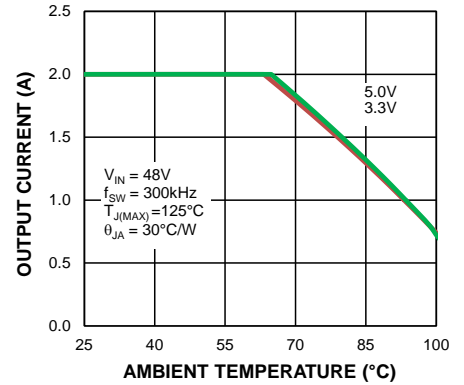

**IC Power Dissipation
vs. Output Current MIC28512-1**

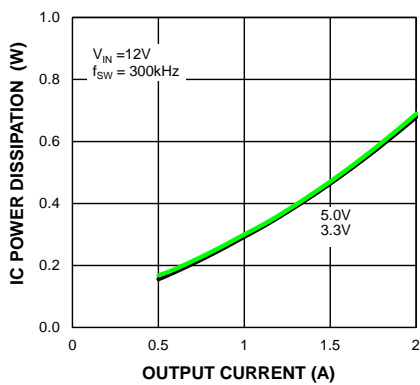

**IC Power Dissipation
vs. Output Current MIC28512-1**

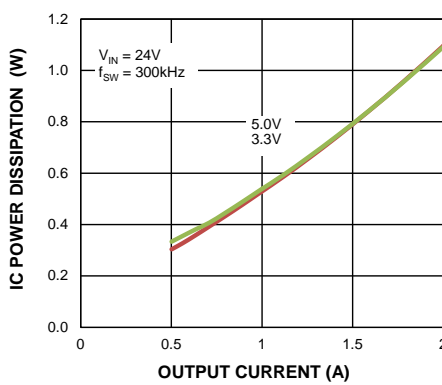

**IC Power Dissipation
vs. Output Current MIC28512-1**

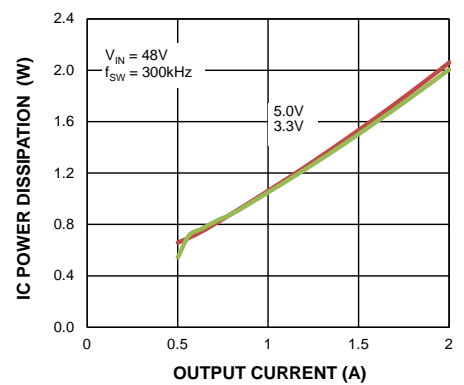

Typical Characteristics (Continued)

**Efficiency (VIN = 12V)
vs. Output Current MIC28512-2**

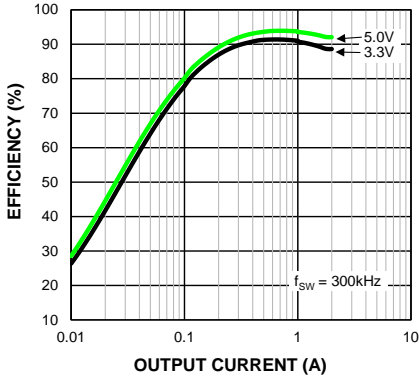

**Efficiency (VIN = 24V)
vs. Output Current MIC28512-2**

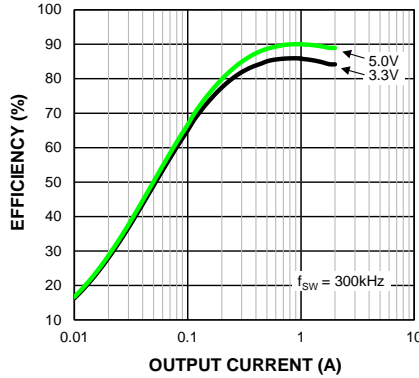

**Efficiency (VIN = 48V)
vs. Output Current MIC28512-2**

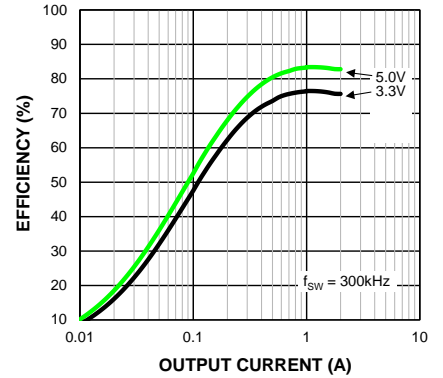

**12V Input Thermal Derating
MIC28512-2**

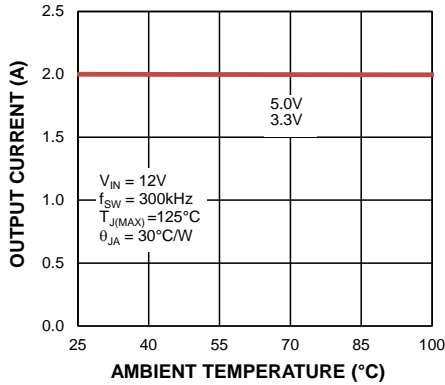

**24V Input Thermal Derating
MIC28512-2**

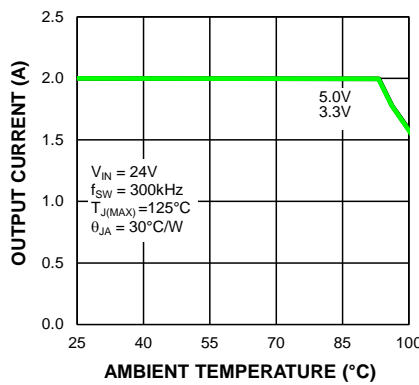

**48V Input Thermal Derating
MIC28512-2**

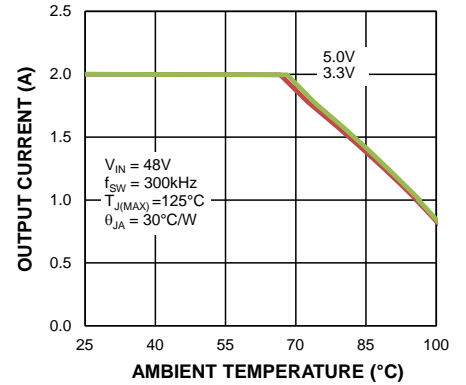

**IC Power Dissipation
vs. Output Current MIC28512-2**

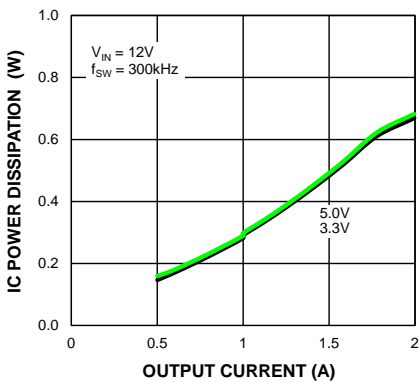

**IC Power Dissipation
vs. Output Current MIC28512-2**

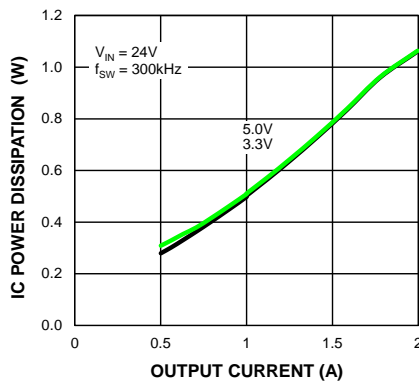

**IC Power Dissipation
vs. Output Current MIC28512-2**

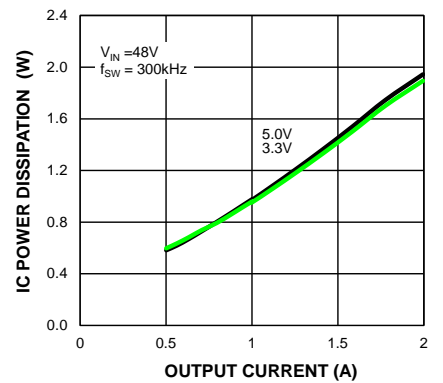

Evaluation Board Schematic

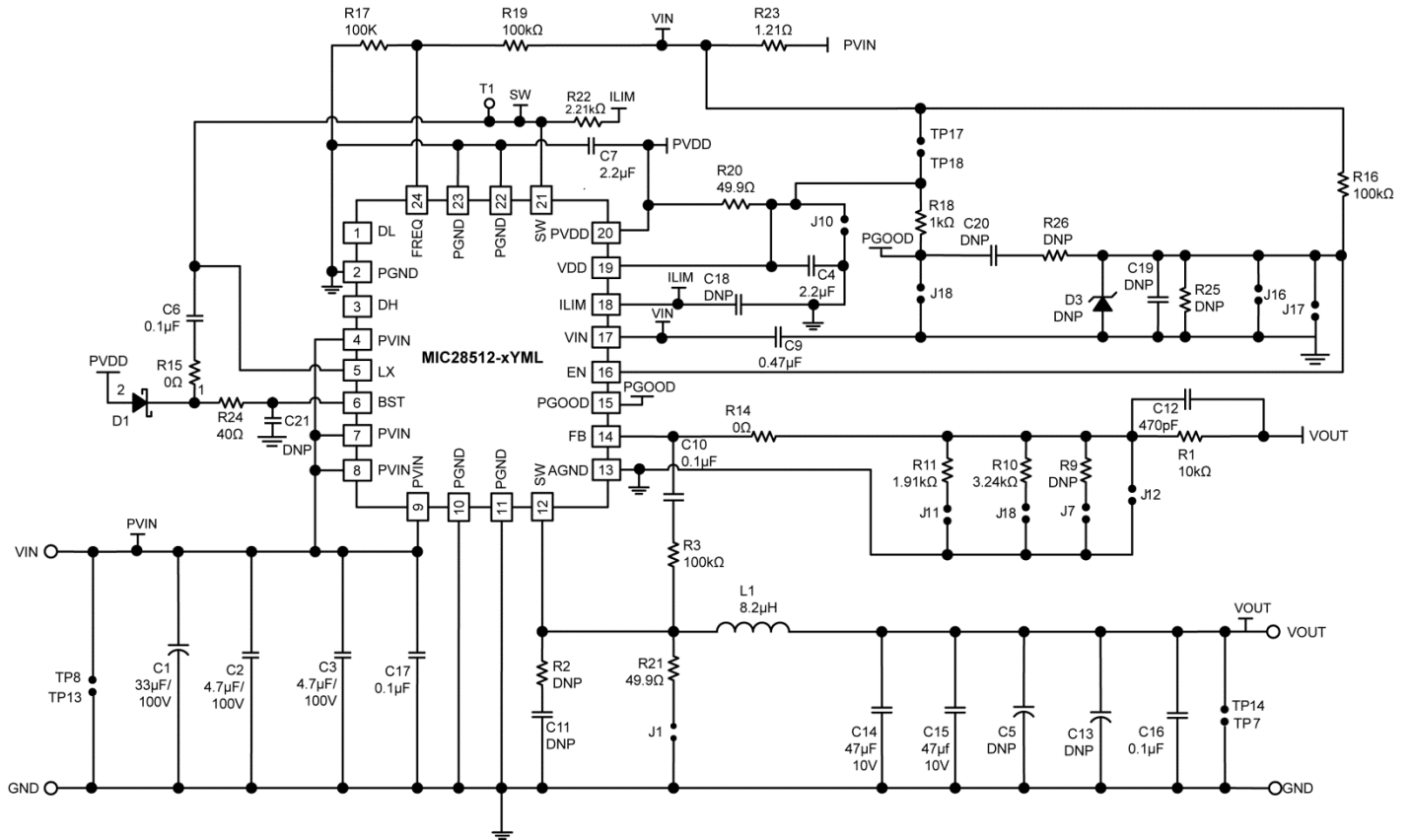

Bill of Materials

Item	Part Number	Manufacturer	Description	Qty.
C1	UVZ2A330MPD	Nichicon ⁽¹⁾	33μF/100V 20% Radial Aluminum Capacitor	1
C2, C3	12061Z475KAT2A	AVX ⁽²⁾	4.7μF/100V, X7S, Size 1206 Ceramic Capacitor	2
C4, C7	C1608X7R1A225K080AC	TDK ⁽³⁾	2.2μF/10V, X7R, Size 0603 Ceramic Capacitor	2
C5, C11, C13, C18, C19, C20, C21			Open	NA
C6, C16	C0603C104K8RACTU	Kemet ⁽⁴⁾	0.1μF/10V, X7R, Size 0603 Ceramic Capacitor	2
C9	GRM21BR72A474KA73	Murata ⁽⁵⁾	0.47μF/100V, X7R, Size 0805 Ceramic Capacitor	1
	08051C474KAT2A	AVX		
C10, C17	GRM188R72A104KA35D	Murata	0.1μF/100V, X7R, Size 0603 Ceramic Capacitor	2
C12	CGA3E2X7R1H102K	TDK	1nF/50V, X7R, Size 0603 Ceramic Capacitor	1

Notes:

1. Nichicon: www.nichicon.co.jp/english.
2. AVX: www.avx.com.
3. TDK: www.tdk.com.
4. Kemet: www.kemet.com.
5. Murata: www.murata.com.

Bill of Materials (Continued)

Item	Part Number	Manufacturer	Description	Qty.
C14, C15	GRM32ER71A476KE15L	Murata	47 μ F/10V, X7R, Size 1210 Ceramic Capacitor	2
D1	BAT46W-TP	MCC ⁽⁶⁾	100V Small Signal Schottky Diode, SOD123	1
D3			Open	NA
J1, J7, J8, J10 – J12, J16 – J18	77311-118-02LF	FCI ⁽⁷⁾	CONN HEADER 2POS VERT T/H	9
L1	XAL7030-822MED	Coilcraft ⁽⁸⁾	8.2 μ H, 10.2A Saturation Current	1
R1	CRCW060310K0FKEA	Vishay Dale ⁽⁹⁾	10.0k Ω , Size 0603, 1% Resistor	1
R2, R9, R25, R26			Open	NA
R10	CRCW06033K24FKEA	Vishay Dale	3.24k Ω , Size 0603, 1% Resistor	1
R11	CRCW06031K91FKEA	Vishay Dale	1.91k Ω , Size 0603, 1% Resistor	1
R14, R15	CRCW06030000FKEA	Vishay Dale	0.0 Ω , Size 0603, Resistor Jumper	2
R3, R16, R17, R19	CRCW0603100K0FKEA	Vishay Dale	100k Ω , Size 0603, 1% Resistor	4
R18	CRCW06031K00JNEA	Vishay Dale	1.0k Ω , Size 0603, 5% Resistor	1
R20, R21	CRCW060349R9FKEA	Vishay Dale	49.9 Ω , Size 0603, 1% Resistor	2
R22	CRCW06032K21FKEA	Vishay Dale	2.21k Ω , Size 0603, 1% Resistor	1
R23	CRCW08051R21FKEA	Vishay Dale	1.21 Ω , Size 0805, 1% Resistor	1
R24	CRCW060340R0FKEA	Vishay Dale	40.0 Ω , Size 0603, 1% Resistor	1
TP7, TP14, TP8, TP13, TP17, TP18			Open	NA
TP9 – TP12	1502	Keystone Electronics ⁽¹⁰⁾	Test Point Turret, .090	4
U1	MIC28512-1YFL	Micrel, Inc. ⁽¹¹⁾	70V/2A Synchronous Buck Regulator	1
	MIC28512-2YFL			

Notes:6. MCC: www.mcc.com.7. FCI: www.fciconnect.com.8. Coilcraft: www.coilcraft.com.9. Vishay Dale: www.vishay.com.10. Keystone Electronics: www.keystone.com.11. Micrel, Inc.: www.micrel.com.

Evaluation Board Layout Recommendations

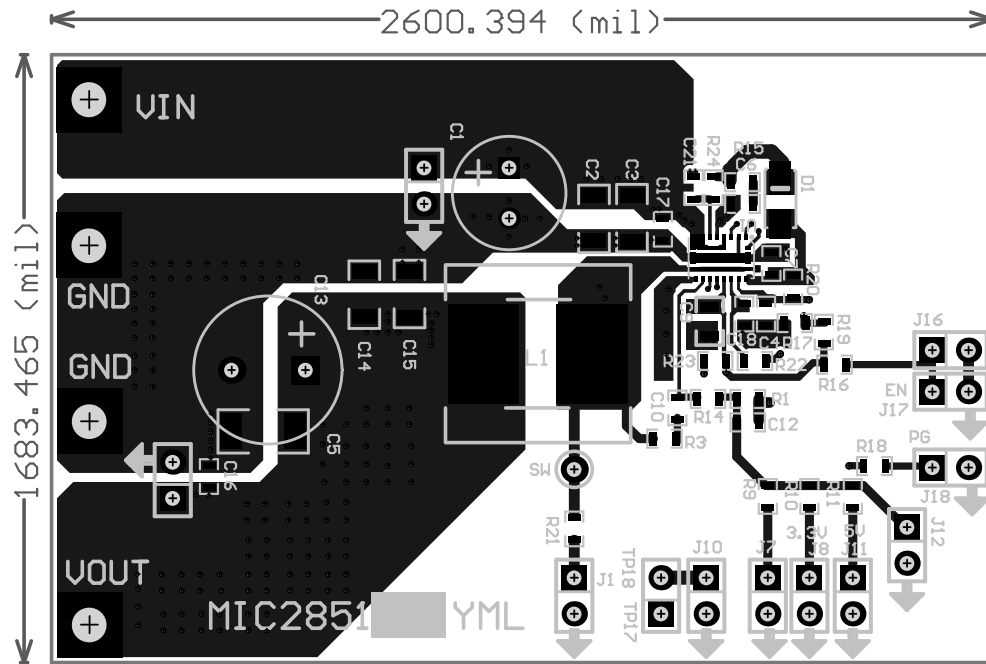

Top Layer

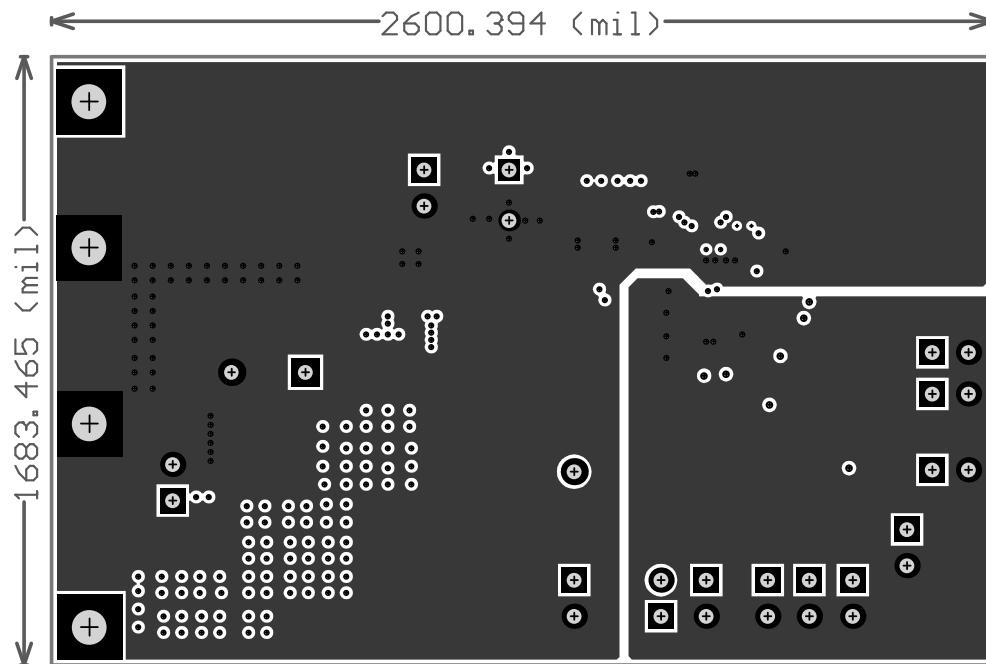

Mid-Layer 1 (Ground Plane)

Evaluation Board Layout Recommendations (Continued)

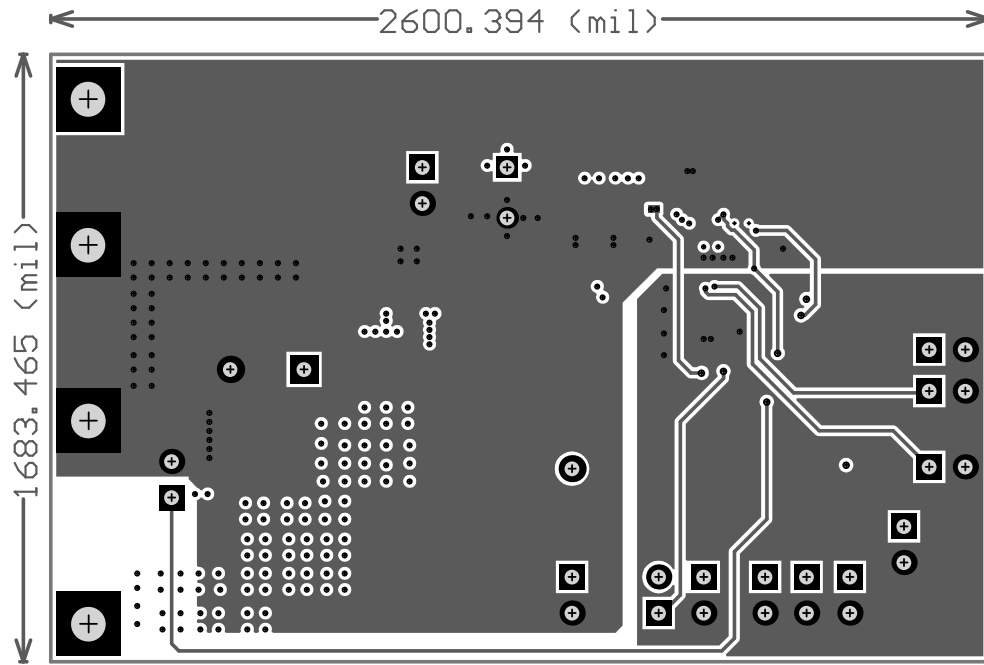

Mid-Layer 2

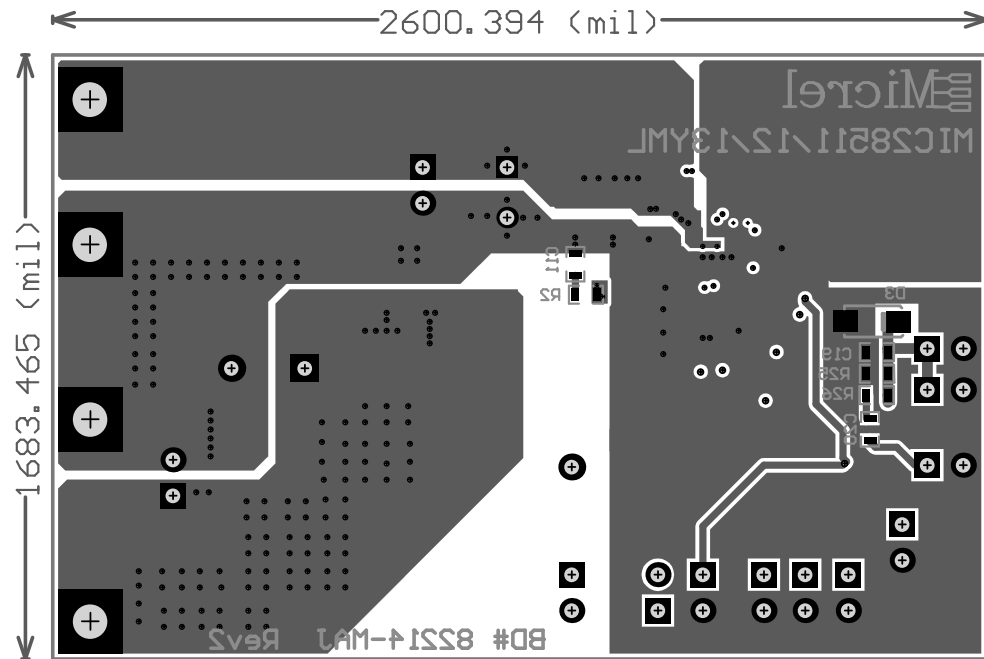

Bottom Layer

MICREL, INC. 2180 FORTUNE DRIVE SAN JOSE, CA 95131 USA
TEL +1 (408) 944-0800 FAX +1 (408) 474-1000 WEB <http://www.micrel.com>

Micrel, Inc. is a leading global manufacturer of IC solutions for the worldwide high-performance linear and power, LAN, and timing & communications markets. The Company's products include advanced mixed-signal, analog & power semiconductors; high-performance communication, clock management, MEMs-based clock oscillators & crystal-less clock generators, Ethernet switches, and physical layer transceiver ICs. Company customers include leading manufacturers of enterprise, consumer, industrial, mobile, telecommunications, automotive, and computer products. Corporation headquarters and state-of-the-art wafer fabrication facilities are located in San Jose, CA, with regional sales and support offices and advanced technology design centers situated throughout the Americas, Europe, and Asia. Additionally, the Company maintains an extensive network of distributors and reps worldwide.

Micrel makes no representations or warranties with respect to the accuracy or completeness of the information furnished in this datasheet. This information is not intended as a warranty and Micrel does not assume responsibility for its use. Micrel reserves the right to change circuitry, specifications and descriptions at any time without notice. No license, whether express, implied, arising by estoppel or otherwise, to any intellectual property rights is granted by this document. Except as provided in Micrel's terms and conditions of sale for such products, Micrel assumes no liability whatsoever, and Micrel disclaims any express or implied warranty relating to the sale and/or use of Micrel products including liability or warranties relating to fitness for a particular purpose, merchantability, or infringement of any patent, copyright, or other intellectual property right.

Micrel Products are not designed or authorized for use as components in life support appliances, devices or systems where malfunction of a product can reasonably be expected to result in personal injury. Life support devices or systems are devices or systems that (a) are intended for surgical implant into the body or (b) support or sustain life, and whose failure to perform can be reasonably expected to result in a significant injury to the user. A Purchaser's use or sale of Micrel Products for use in life support appliances, devices or systems is a Purchaser's own risk and Purchaser agrees to fully indemnify Micrel for any damages resulting from such use or sale.

© 2015 Micrel, Incorporated.