

The copying, distribution and utilization of this document as well as the communication of the contents to others without expressed authorization is prohibited according to §18 UWG German Law. Offenders will be held liable for the payment of damages according to §9 UWG German Law. All rights reserved, in particular the right to carry out patent utility model or ornamental design registrations.
 Flachsmarktstraße 8 D-32825 Blomberg
 Phoenix Contact GmbH & Co. KG

MSTBO 2,5/ 3-G1L-5,0

MSTBO 2,5/ 3-G1R-5,0

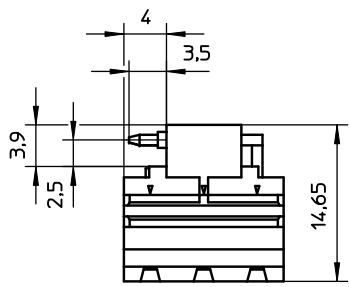
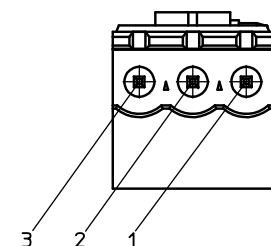
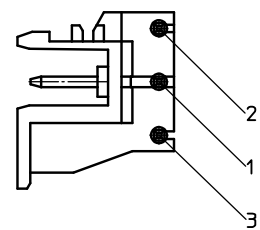
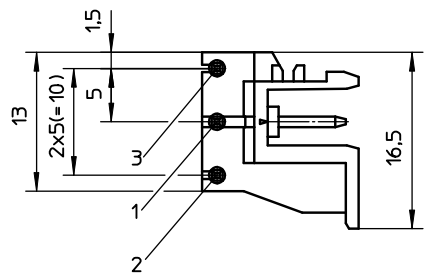
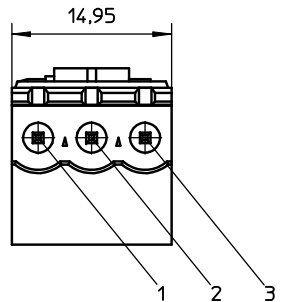

Recommended
Drilling Plan
view: component side

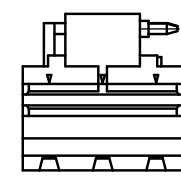
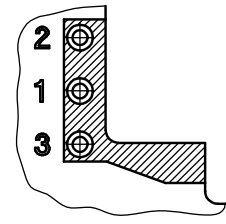
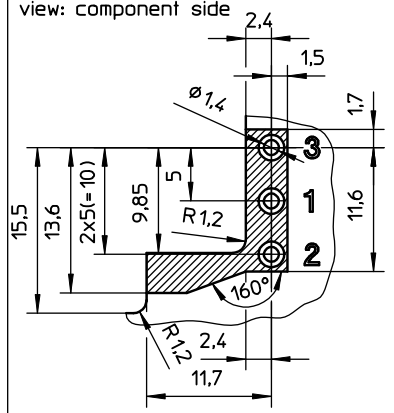

General Information

- Simplified representation
- Restricted area
- Document excluded from change process
- CAD Data see Download-Center on www.phoenixcontact.com
- When using the base strip in housings from Phoenix Contact the PCB outline housing series must be used.

						00	date	name	ident.-No. / RI	material	scale	dim.var.
						creat.	01.06.10	pboa01	----- / --	-----	2:1	
						check	30.05.11	evbf02	SAP change-No.	part-rev.		
									document-type	document-No.	surface in µm	
									KUNDENZCHNG-SELECT	00556313		
									description	MSTBO 2,5/ 3-G1L/R-5,0		
RI	date	revision	name	check.on	name	page	of 1					