

DATA SHEET

# SKY65009-70LF: 250 to 2500 MHz Linear Power Amplifier Driver

## Applications

- UHF television, CATV, DBS
- TETRA radio
- GSM, GPRS, CDMA, WCDMA
- AMPS, PCS,DCS
- ISM band transmitters
- Fixed WCS
- WLAN, WiMAX
- RFID

## Features

- Wideband frequency range: 250 to 2500 MHz
- High linearity OIP3: +40 dBm
- Output P1 dB > +25 dBm
- High efficiency: PAE 40%
- Single DC supply: 3.3 V or 5 V
- On-chip bias circuit
- Low power consumption
- SOT-89 (4-pin 2.4 x 4.5 mm) Pb-free, ROHS-compliant package (MSL1, 260 °C per JEDEC J-STD-0-20)



Skyworks Green™ products are compliant with all applicable legislation and are halogen-free. For additional information, refer to *Skyworks Definition of Green™*, document number SQ04-0074.

## Description

Skyworks SKY65009-70LF is a high-performance, ultra-wideband power amplifier (PA) driver with superior output power, noise figure, linearity, and efficiency. The high linearity and superior adjacent channel power rejection/adjacent channel leakage ratio (ACPR/ACLR) performance make the SKY65009-LF ideal for use in the driver stage of infrastructure transmit chains.

The SKY65045-70LF is fabricated with Skyworks high-reliability Aluminum (Al) Gallium Arsenide (GaAs) Heterojunction Bipolar Transistor (HBT) process, which allows for single-supply operation while maintaining high efficiency and good linearity. The device uses low-cost surface-mount technology (SMT) in the form of a 2.4 x 4.5 mm small outline transistor (SOT-89) package.

The module can operate over a temperature range of -40 °C to +85 °C. A populated Evaluation Board is available upon request.

A functional block diagram is provided in Figure 1.

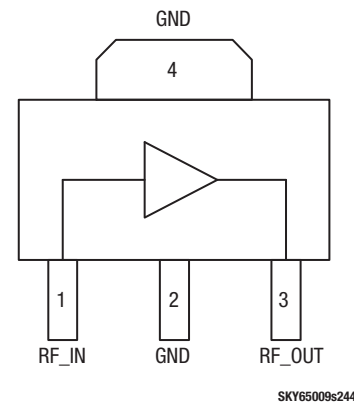

**Figure 1. SKY65009-70LF Functional Block Diagram**

## Technical Description

The SKY65009-70LF is a single-stage, wideband PA in a low-cost surface-mount package. The device operates with a single 3 V or 5 V power supply connected through an RF choke (L1) to the output pin. Capacitors C7, C8, and C9 provide DC bias decoupling for VCC.

The bias current is set by the on-chip active bias composed of current mirror and reference voltage transistors, allowing for excellent gain tracking over temperature and voltage variations. The part is externally RF matched using surface mount components to facilitate operation over a frequency range of 250 MHz to 2500 MHz.

Pin 1 is the RF input and pin 3 is the RF output. External DC blocking is required for both input and output, but can be implemented as part of the RF matching circuit. Pin 2 and the package backside metal, pin 4, provide the DC and RF ground.

## Electrical and Mechanical Specifications

Signal pin assignments and functional pin descriptions for the SKY65009 are provided in Table 1. The absolute maximum ratings are provided in Table 2, and the recommended operating

conditions in Table 3. Electrical characteristics for the SKY65009 are provided in Table 4.

Typical performance characteristics of the SKY65009 are illustrated in Figures 2 through 92.

## Package and Handling Information

Instructions on the shipping container label regarding exposure to moisture after the container seal is broken must be followed. Otherwise, problems related to moisture absorption may occur when the part is subjected to high temperature during solder assembly.

The SKY65009 is rated to Moisture Sensitivity Level 1 (MSL1) at 260 °C. It can be used for lead or lead-free soldering. For additional information, refer to the Skyworks Application Note, Solder Reflow Information, document number 200164.

Care must be taken when attaching this product, whether it is done manually or in a production solder reflow environment. Production quantities of this product are shipped in a standard tape and reel format.

**Table 1. SKY65009 Signal Descriptions<sup>1</sup>**

Pin	Name	Description
1	RF_IN	RF input
2	GND	Ground
3	RF_OUT	RF output/VCC
4	GND	Center ground

<sup>1</sup> Center attachment pad must have low inductance and low thermal resistance connections to the customer's printed circuit board ground plane.

**Table 2. SKY65009 Absolute Maximum Ratings**  
( $T_A = +25\text{ }^\circ\text{C}$ , Unless Otherwise Noted) <sup>1</sup>

Parameter	Symbol	Value	Units
RF output power	POUT	+26	dBm
Supply voltage	VCC	6	V
Supply current	ICC	300	mA
Power dissipation	Pd	1.1	W
Operating case temperature range	Tc	-40 to +85	°C
Storage temperature range	TST	-55 to +125	°C
Junction temperature	TJ	150	°C

<sup>1</sup> Performance is guaranteed only under the conditions listed in the specifications table and is not guaranteed under the full range(s) described by the Absolute Maximum specifications. Exceeding any of the absolute maximum/minimum specifications may result in permanent damage to the device and will void the warranty.

**ESD HANDLING:** Although this device is designed to be as robust as possible, electrostatic discharge (ESD) can damage this device. This device must be protected at all times from ESD when handling or transporting. Static charges may easily produce potentials of several kilovolts on the human body or equipment, which can discharge without detection. Industry-standard ESD handling precautions should be used at all times.

**Table 3. SKY65009 Recommended Operating Conditions**

Parameter	Symbol	Min	Typical	Max	Units
Supply voltage	VCC		5	5.5	V
Operating frequency	fo	100		2500	MHz
Operating case temperature	Tc	-40	+25	+85	°C
Thermal resistance (junction to case)	$\theta_{JC}$		20		°C/W

**Table 4. SKY65009 Electrical Characteristics (Note 1) (1 of 3)**  
( $V_{CC} = 5.0\text{ V}$ , Output Impedance =  $50\ \Omega$ ,  $T_c = 25\text{ }^\circ\text{C}$ , Unless Otherwise Noted)

Parameter	Symbol	Test Conditions	Min	Typical	Max	Units
<i>Test Frequency = 450 MHz</i>						
Frequency	f			450		MHz
Small signal gain	S21	PIN = -15 dBm		22		dB
Input return loss	S11	Small signal		14.5		dB
Output return loss	S22	Small signal		11.5		dB
1 dB output compression point	OP1db	CW		+26.8		dBm
Power-added efficiency	PAE	@ P1dB		38.5		%
Third order output intercept point	OIP3	PIN/tone = 0 dBm, $\Delta f = 1\text{ MHz}$		+35		dBm
Noise figure	NF	PIN = -15 dBm		6.5		dB
Quiescent current	ICCQ	No RF		100		mA

**Table 4. SKY65009 Electrical Characteristics<sup>1</sup> (2 of 3)**  
**(VCC = 5.0 V, Output Impedance = 50 Ω, Tc = 25 °C, Unless Otherwise Noted)**

Parameter	Symbol	Test Conditions	Min	Typical	Max	Units
<b>Test Frequency = 900 MHz</b>						
Frequency	f			900		MHz
Small signal gain	S21	Pin = -15 dBm		17		dB
Input return loss	S11	Small signal		9		dB
Output return loss	S22	Small signal		7.5		dB
1 dB output compression point	P1db	CW		+25.0		dBm
Power-added efficiency	PAE	@ P1dB		33		%
Third order output intercept point	OIP3	Pin/tone = 0 dBm, Δf = 1 MHz		+41		dBm
Power out @ ACPR = -45 dBc	ACPR	IS-95, 750 kHz offset		19		dBm
Noise figure	NF	Small signal		5		dB
Quiescent current	Iccq	No RF		100		mA
<b>Test Frequency = 1960 MHz</b>						
Frequency	f	Best OIP3 match		1960		MHz
Small signal gain	S21	Pin = -15 dBm	10.5	12		dB
Input return loss	S11	Small signal		19		dB
Output return loss	S22	Small signal		10.5		dB
1 dB output compression point	OP1db	CW	+26	+27		dBm
Power-added efficiency	PAE	@ P1dB	40	47		%
Third order output intercept point	OIP3	Pin/tone = 0 dBm, Δf = 1 MHz	+37	+42		dBm
Power out @ ACPR = -45 dBc	ACPR	IS-95, 885 kHz offset	+18	+20		dBm
Noise figure	NF	Pin = -15 dBm		4.3	5.5	dB
Quiescent current	Iccq	No RF		100	130	mA
<b>Test Frequency = 2140 MHz</b>						
Frequency	f			2140		MHz
Small signal gain	S21	Small signal		11.5		dB
Input return loss	S11	Small signal		20		dB
Output return loss	S22	Small signal		9.5		dB
1 dB output compression point	OP1db	CW		+26.7		dBm
Power-added efficiency	PAE	@ P1dB		48		%
Third order output intercept point	OIP3	Pin/tone = 0 dBm, Δf = 1 MHz		+42.5		dBm
Power out @ ACPR = -45 dBc	ACPR	3G WCDMA, downlink 64 DPCH, 5 MHz offset		+18		dBm
Noise figure	NF	Pin = -15 dBm		18		dB
Quiescent current	Iccq	Pin = -15 dBm		100		mA

**Table 4. SKY65009 Electrical Characteristics<sup>1</sup> (3 of 3)**  
**(VCC = 5.0 V, Output Impedance = 50  $\Omega$ , Tc = 25 °C, Unless Otherwise Noted)**

Parameter	Symbol	Test Conditions	Min	Typical	Max	Units
<i>Test Frequency = 2450 MHz</i>						
Frequency	f			2450		MHz
Small signal gain	S21	PIN = -15 dBm		10.3		dB
Input return loss	S11	Small signal		22		dB
Output return loss	S22	Small signal		15		dB
1 dB output compression point	OP1db	CW		+25.5		dBm
Power-added efficiency	PAE	@ P1dB		38.7		%
Third order output intercept point	OIP3	PIN/tone = 0 dBm, $\Delta f = 1$ MHz		+40		dBm
Noise figure	NF	Small signal		4.1		dB
Quiescent current	ICQ	PIN = -15 dBm		100		mA

<sup>1</sup> Performance is guaranteed only under the conditions listed in this table.

### Typical Performance Data

(VCC = 5 V, f = 450 MHz, CW, Output Impedance = 50 Ω, Tc = 25 °C, Unless Otherwise Noted)

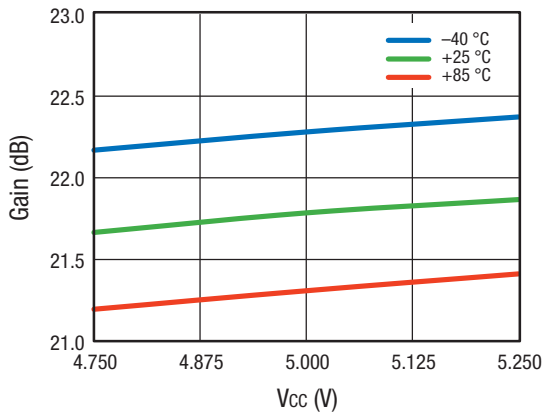

**Figure 2. Gain vs VCC Across Temperature**  
Input Power = -15 dBm

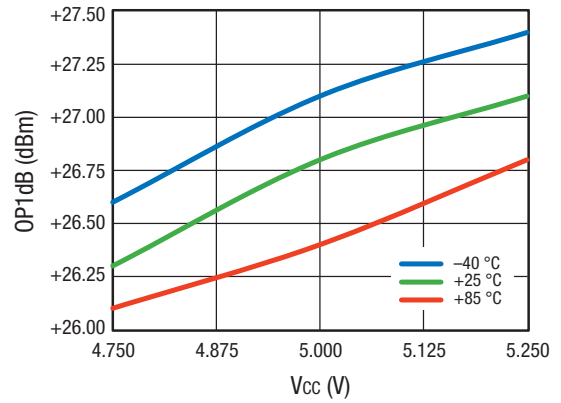

**Figure 3. OP1 dB vs VCC Across Temperature**

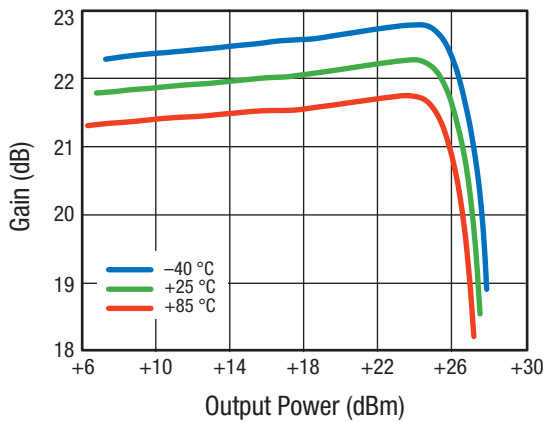

**Figure 4. Gain vs Output Power Across Temperature**

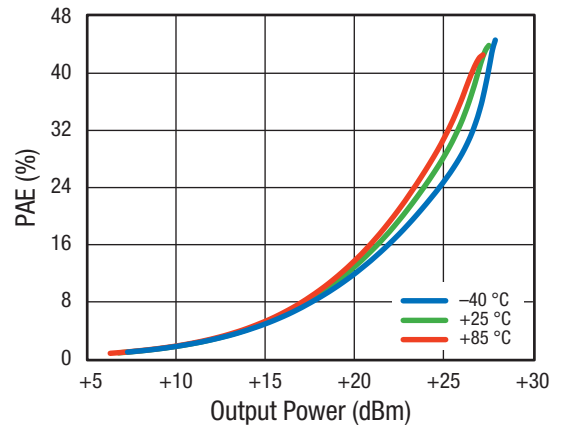

**Figure 5. PAE vs Output Power Across Temperature**

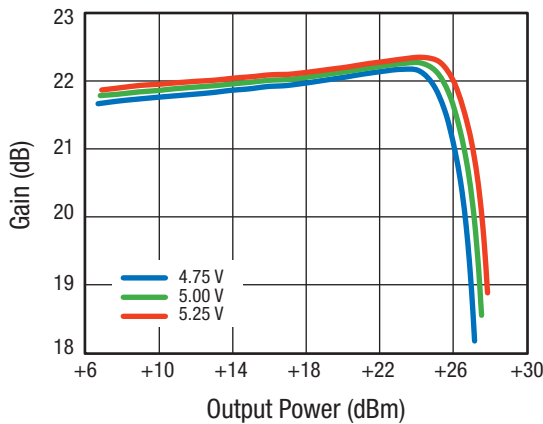

**Figure 6. Gain vs Output Power Across Voltage**

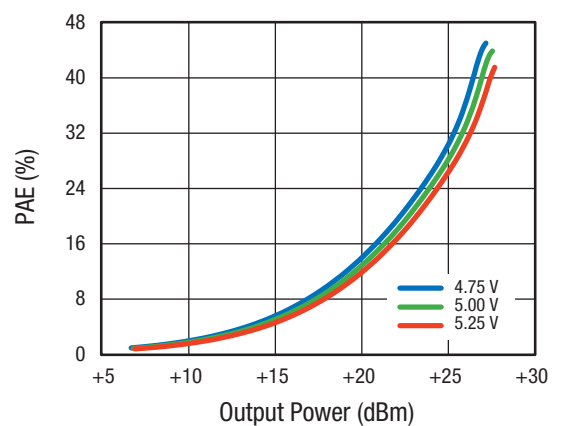

**Figure 7. PAE vs Output Power Across Voltage**

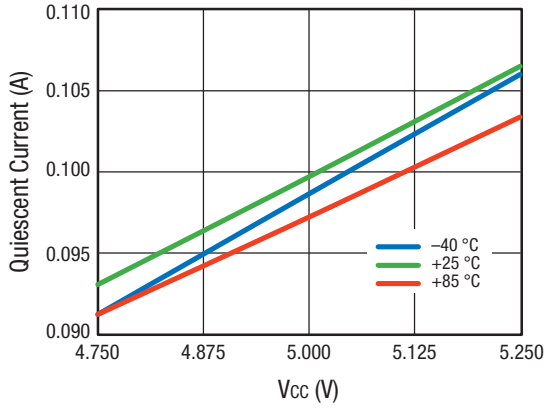

Figure 8. Quiescent Current vs VCC Across Temperature

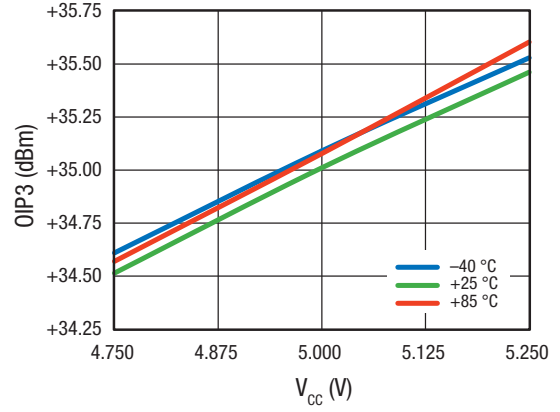

Figure 9. OIP3 vs VCC Across Temperature  
Input Power/Tone = -5 dBm

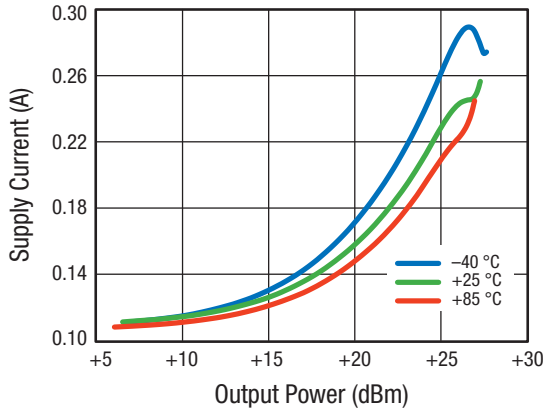

Figure 10. Supply Current vs Output Power Across Temperature

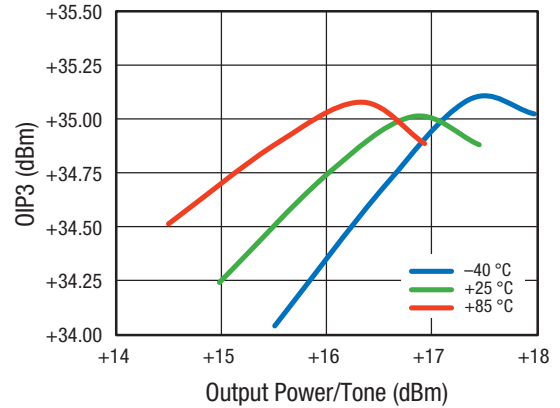

Figure 11. OIP3 vs Output Power/Tone Across Temperature

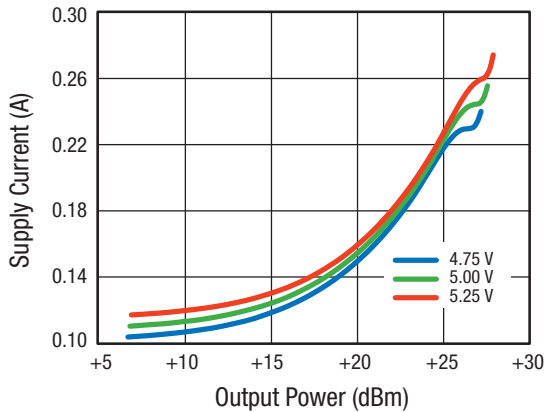

Figure 12. Supply Current vs Output Power Across Voltage

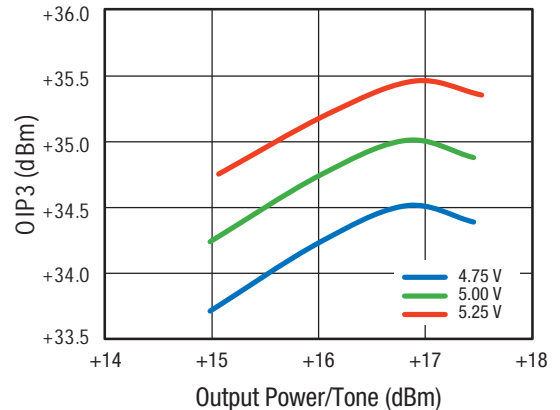

Figure 13. OIP3 vs Output Power/Tone Across Voltage

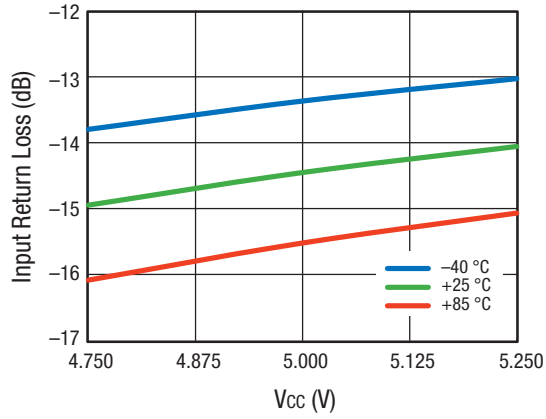

Figure 14. Input Return Loss vs VCC Across Temperature

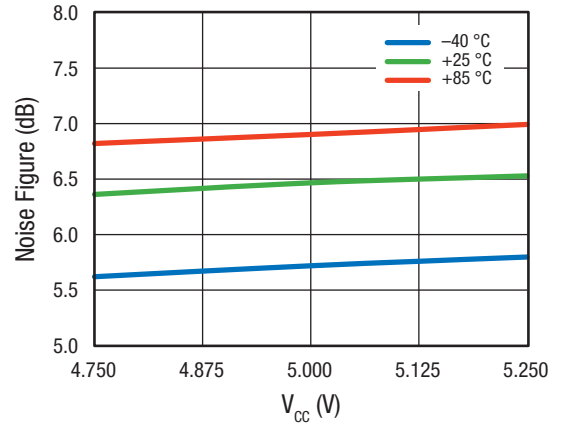
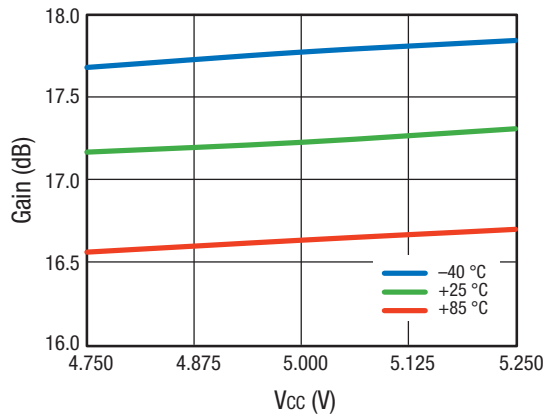

Figure 15. Noise Figure vs VCC Across Temperature



### Typical Performance Data

(VCC = 5 V, f = 900 MHz, CW, Output Impedance = 50 Ω, Tc = 25 °C, Unless Otherwise Noted)



**Figure 16. Gain vs VCC Across Temperature**  
Input Power = -15 dBm

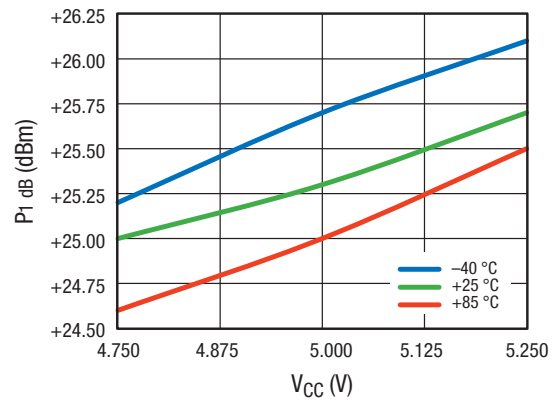

**Figure 17. P1 dB vs VCC Across Temperature**

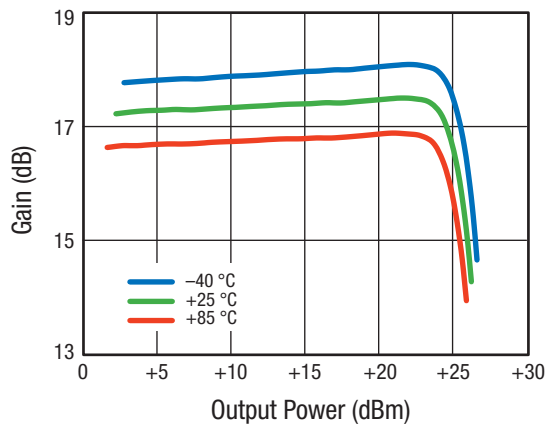

**Figure 18. Gain vs Output Power Across Temperature**

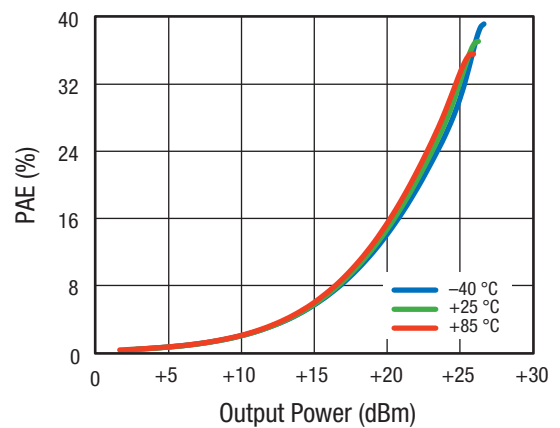

**Figure 19. PAE vs Output Power Across Temperature**

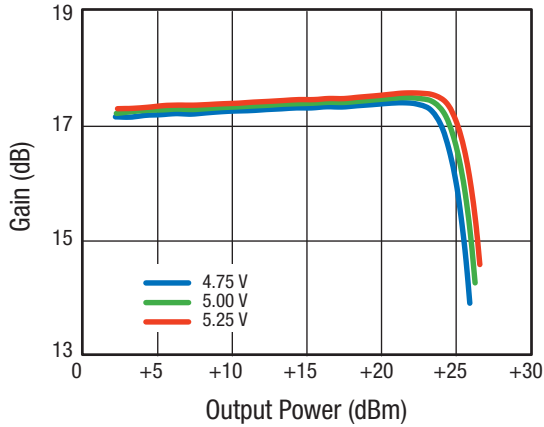

Figure 20. Gain vs Output Power Across VCC

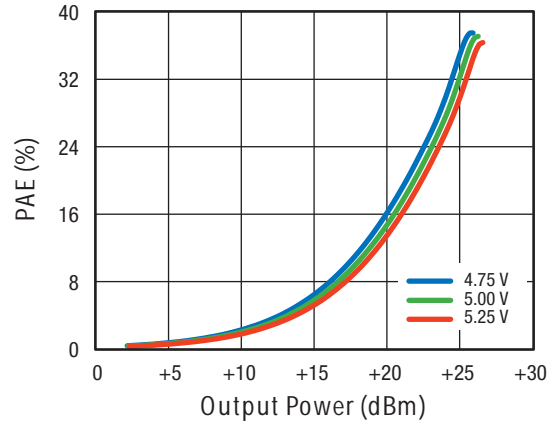

Figure 21. PAE vs Output Power Across VCC

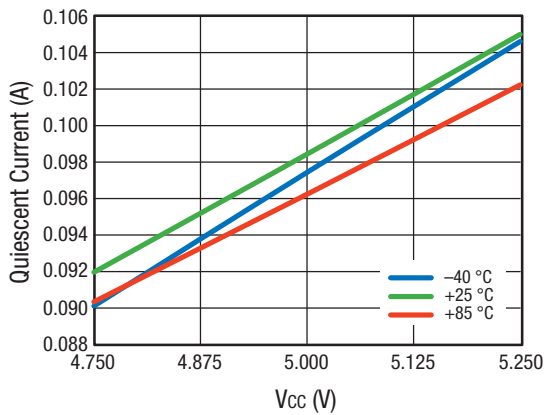

Figure 22. Quiescent Current vs VCC Across Temperature

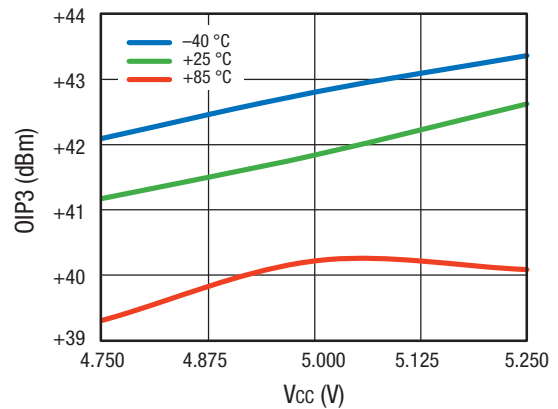

Figure 23. OIP3 vs VCC Across Temperature, Input Power/Tone = -2 dBm

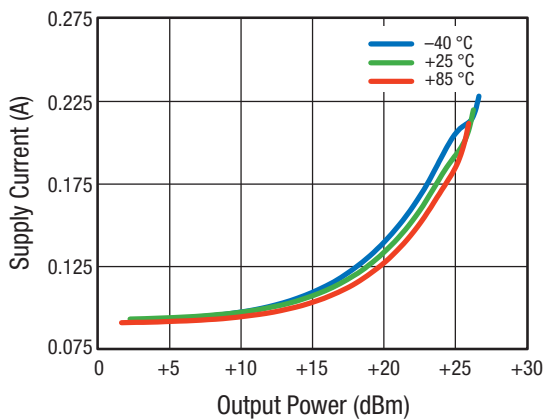

Figure 24. Supply Current vs Output Power Across Temperature

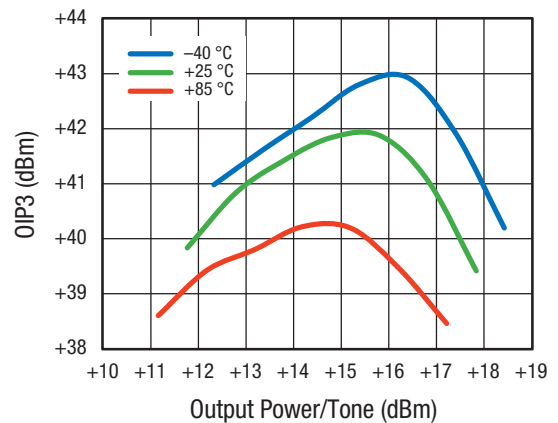

Figure 25. OIP3 vs Output Power/Tone Across Temperature

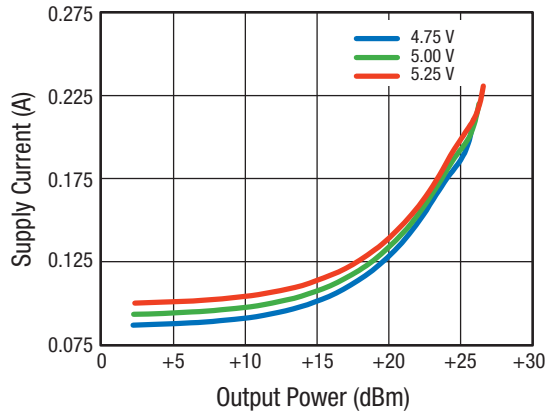

Figure 26. Supply Current vs Output Power Across VCC

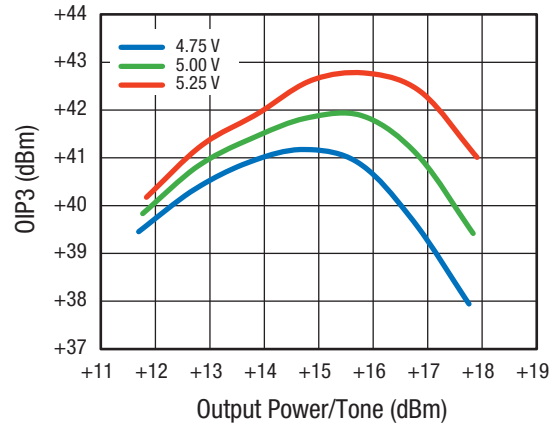

Figure 27. OIP3 vs Output Power/Tone Across VCC

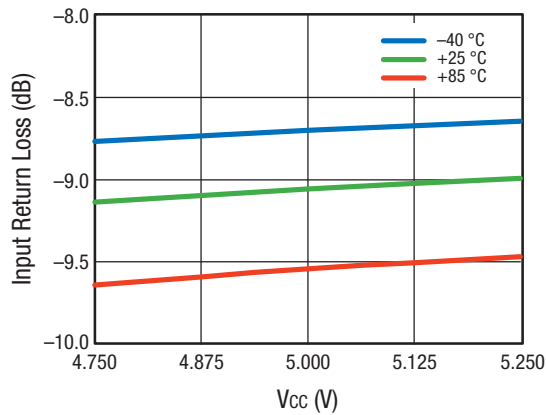

Figure 28. Input Return Loss vs VCC Across Temperature

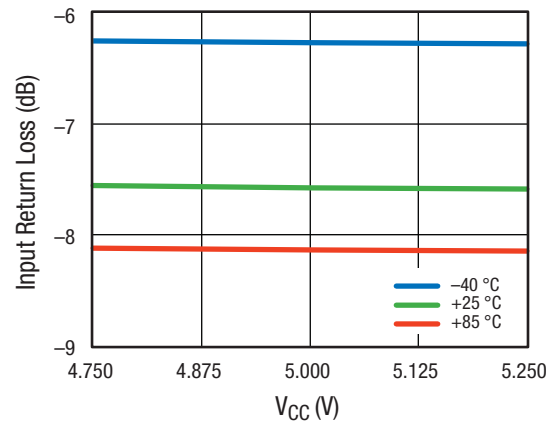

Figure 29. Input Return Loss vs VCC Across Temperature

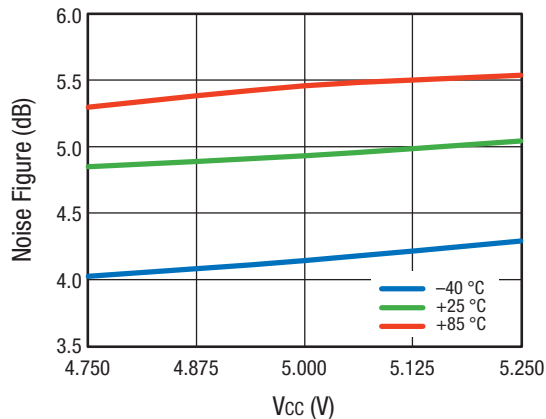

Figure 30. Noise Figure vs VCC Across Temperature

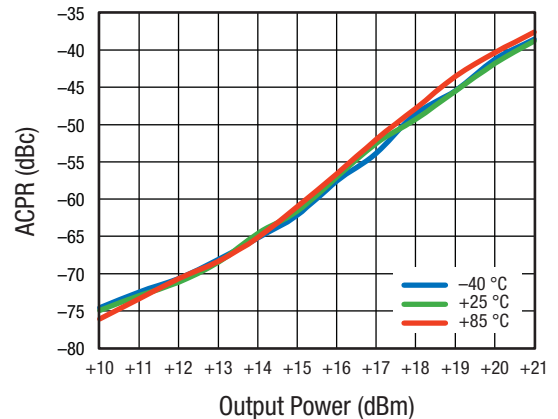
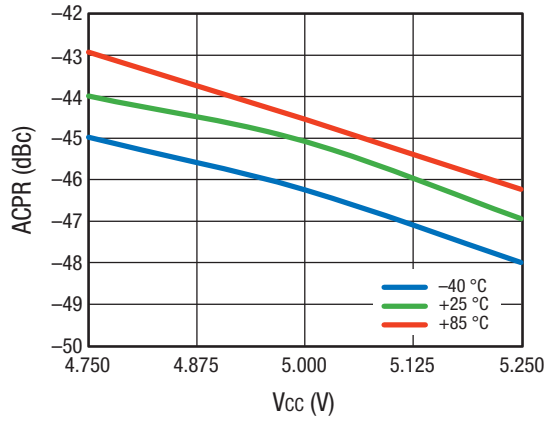
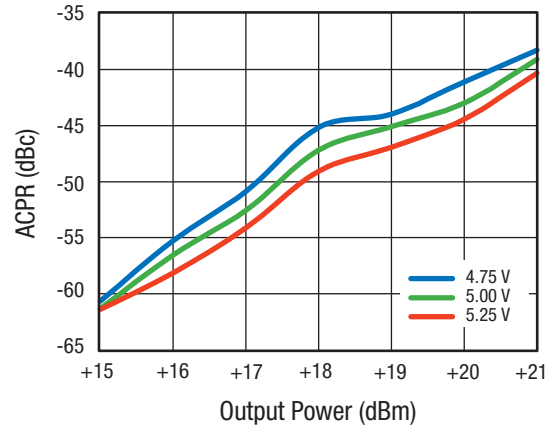

Figure 31. ACPR vs Output Power Across Temperature



**Figure 32. ACPR vs VCC Across Temperature @ Output Power = +19 dBm**



**Figure 33. ACPR vs Output Power Across VCC**

**Typical Performance Data**

(VCC = 5 V, f = 1960 MHz (Best OIP3 Match), CW, Output Impedance = 50 Ω, Tc = 25 °C, Unless Otherwise Noted)

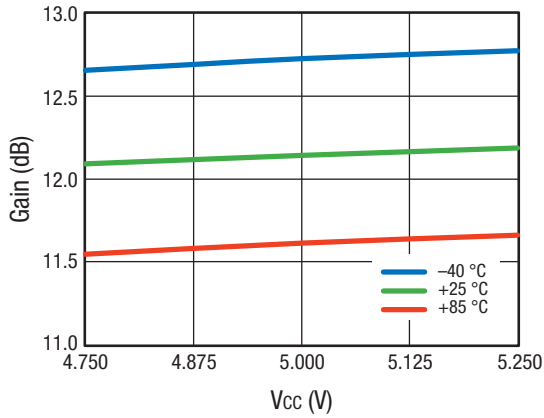

**Figure 34. Gain vs VCC Across Temperature @ Input Power = -15 dBm**

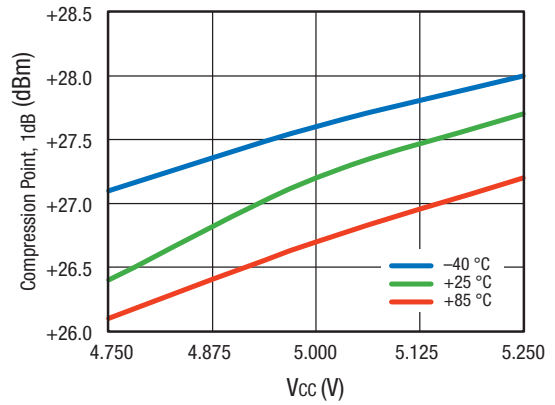

**Figure 35. P1dB vs VCC Across Temperature**

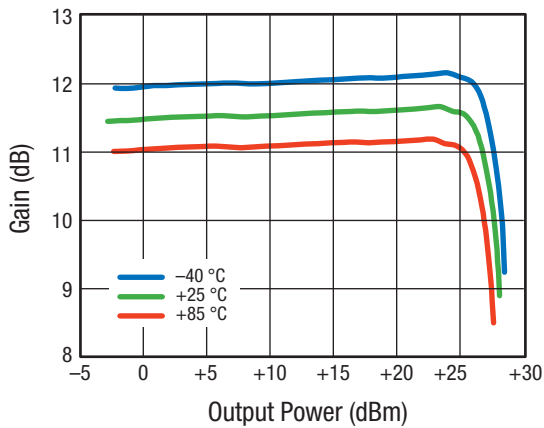

**Figure 36. Gain vs Output Power Across Temperature**

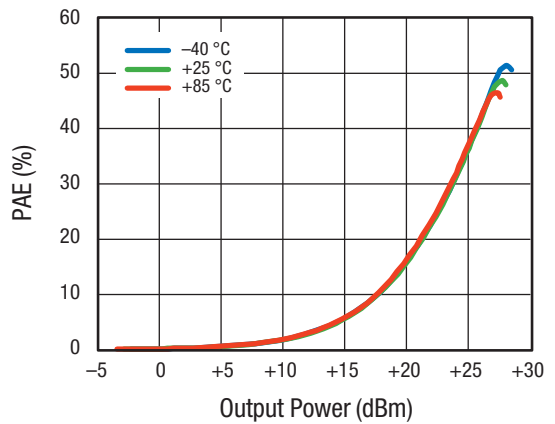

**Figure 37. PAE vs Output Power Across Temperature**

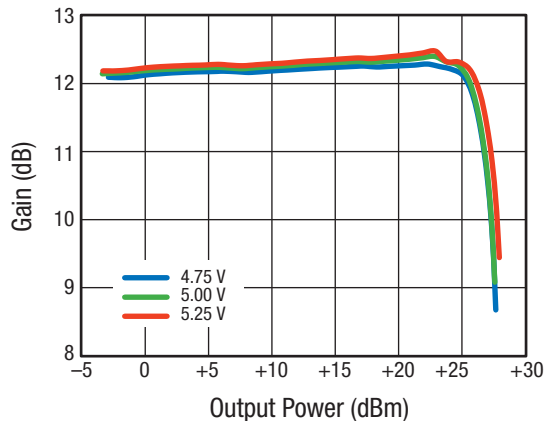

Figure 38. Gain vs Output Power Across VCC

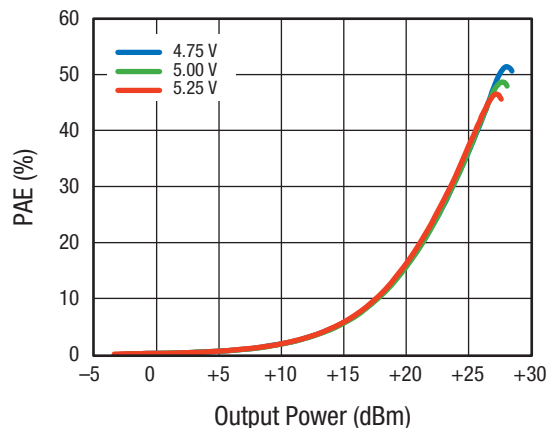

Figure 39. PAE vs Output Power Across VCC

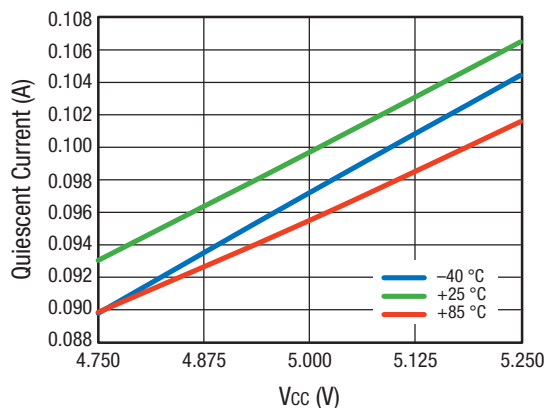

Figure 40. Quiescent Current vs VCC Across Temperature

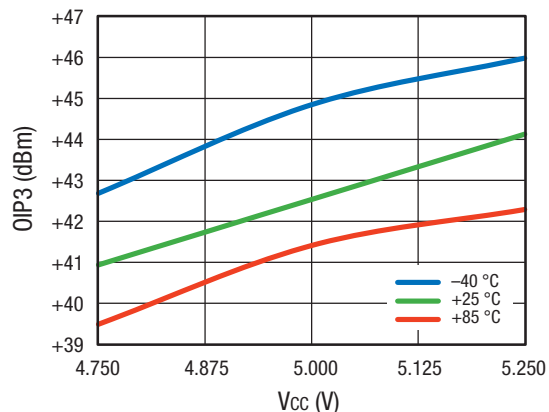

Figure 41. OIP3 vs VCC Across Temperature  
Input Power/Tone = -1 dB

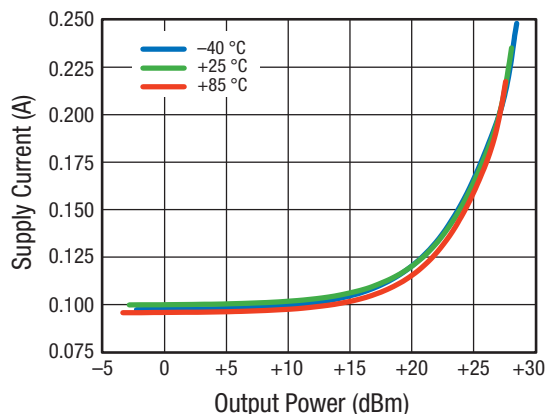

Figure 42. Supply Current vs Output Power Across Temperature

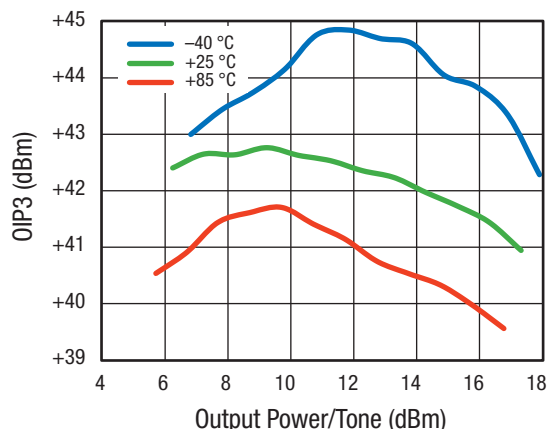

Figure 43. OIP3 vs Output Power/Tone Across Temperature

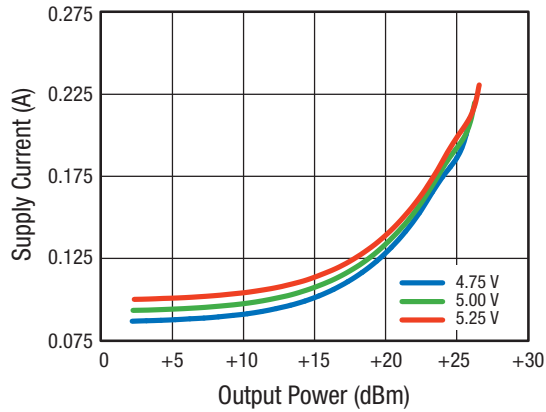

Figure 44. Supply Current vs Output Power Across VCC

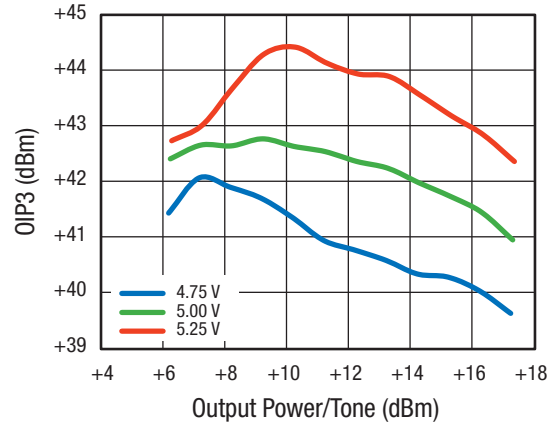

Figure 45. OIP3 vs Output Power/Tone Across VCC

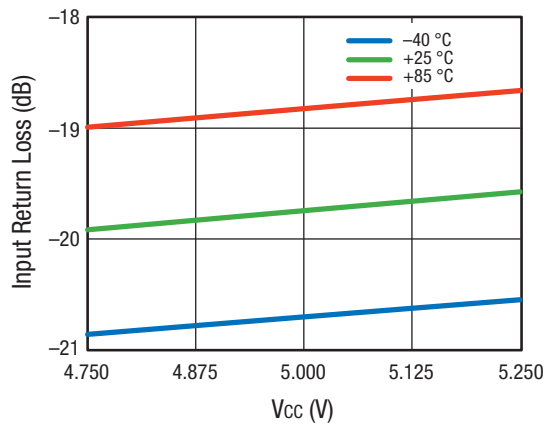

Figure 46. Input Return Loss vs VCC Across Temperature

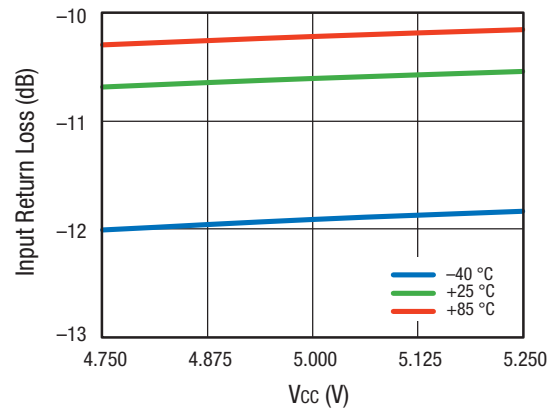

Figure 47. Input Return Loss vs VCC Across Temperature

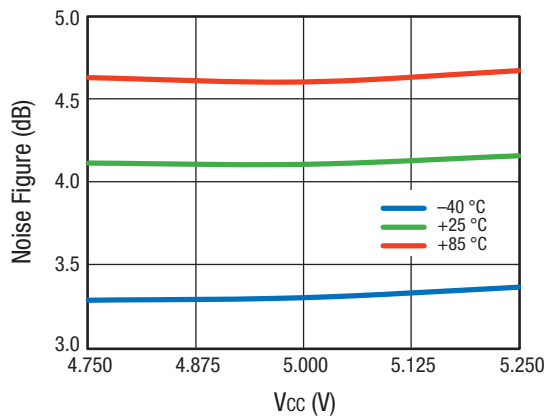

Figure 48. Noise Figure vs VCC Across Temperature

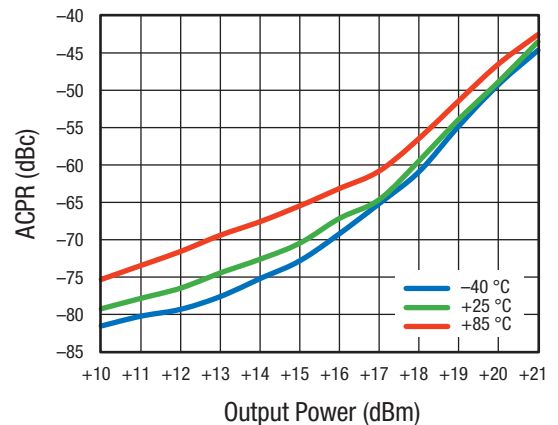
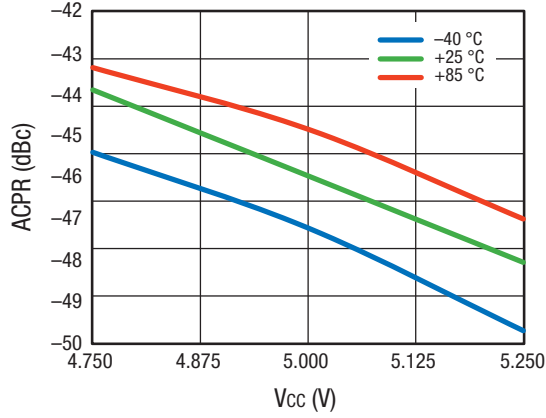
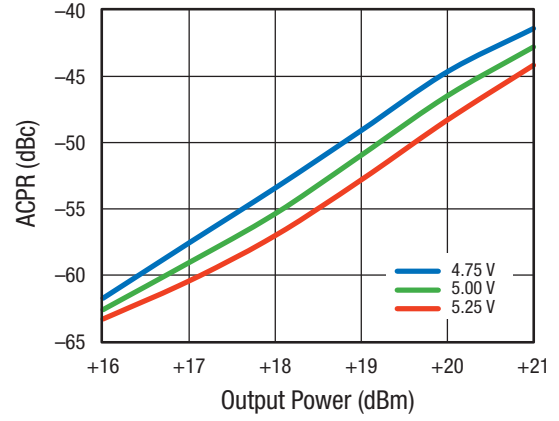

Figure 49. ACPR vs Output Power Across Temperature



**Figure 50. ACPR vs VCC Across Temperature**  
Output Power = 20 dBm



**Figure 51. ACPR vs Output Power Across VCC**



### Typical Performance Data

(VCC = 5 V, f = 2140 MHz, CW, Output Impedance = 50 Ω, Tc = 25 °C, Unless Otherwise Noted)

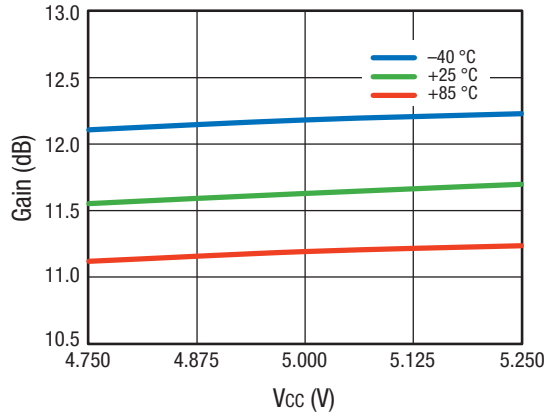

Figure 52. Gain vs VCC Across Input Power -15 dBm

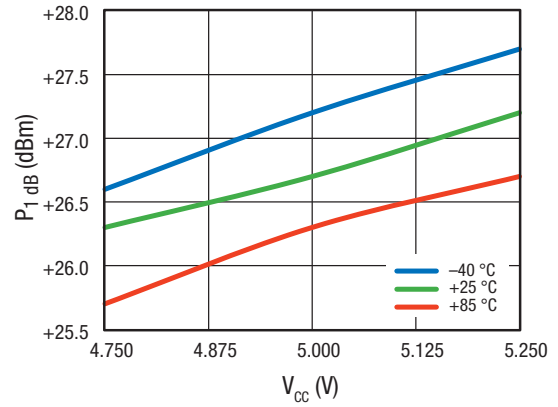

Figure 53. P1 dB vs VCC Across Temperature

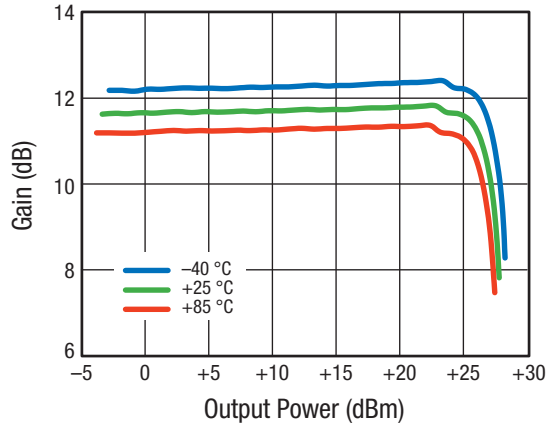

Figure 54. Gain vs Output Power Across Temperature

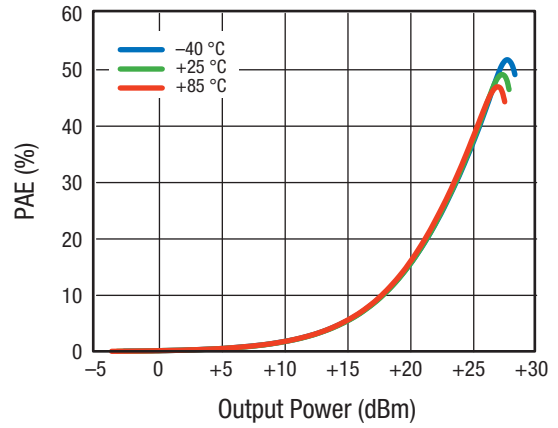

Figure 55. PAE vs Output Power Across Temperature

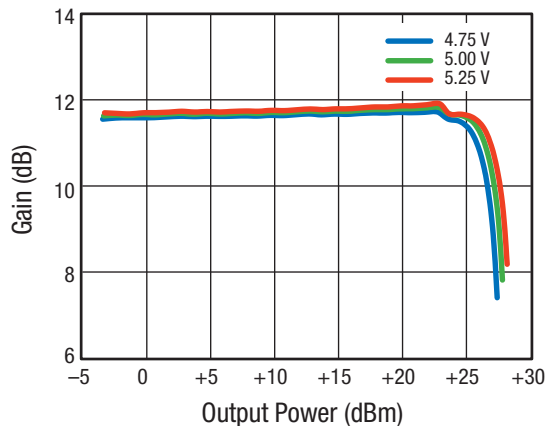

Figure 56. Gain vs Output Power Across VCC

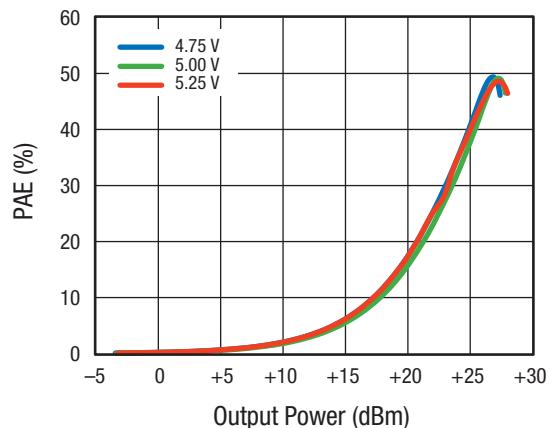

Figure 57. PAE vs Output Power Across VCC

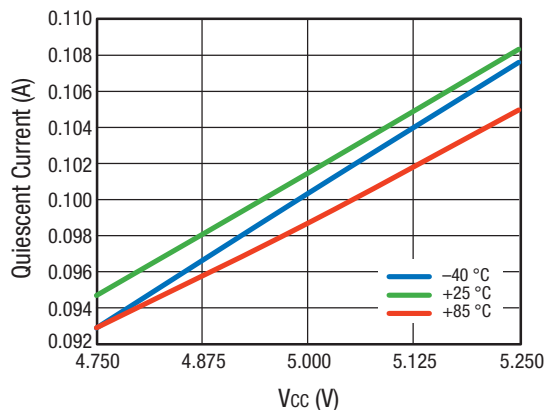

Figure 58. Quiescent Current vs VCC Across Temperature

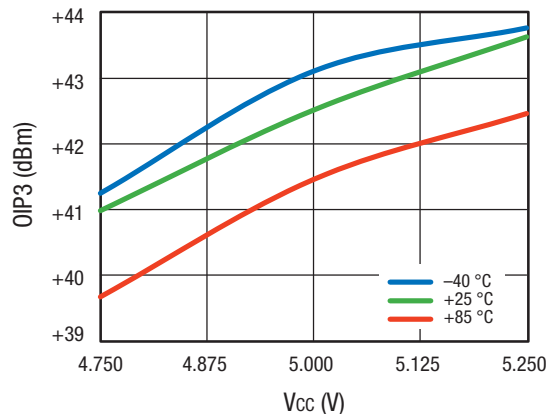

Figure 59. OIP3 vs VCC Across Temperature  
Input Power/Tone = 0 dBm

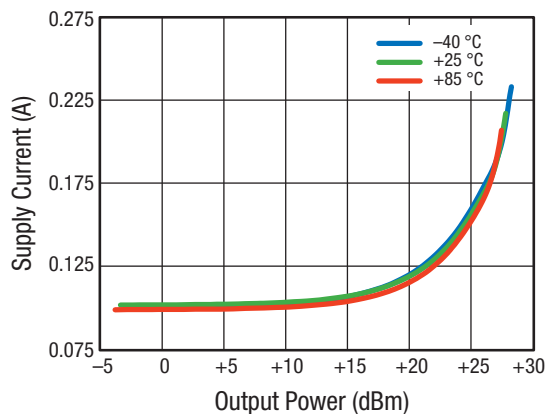

Figure 60. Supply Current vs Output Power Across Temperature

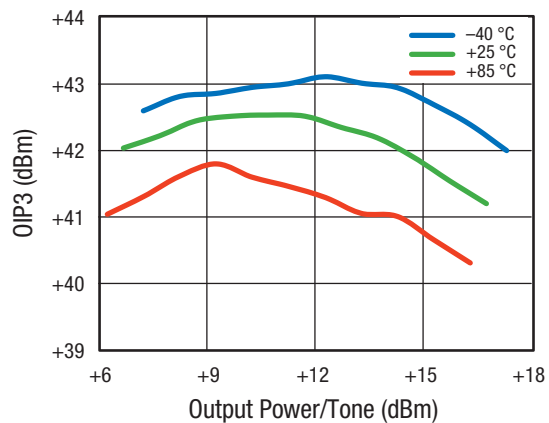

Figure 61. OIP3 vs Output Power/Tone Across Temperature

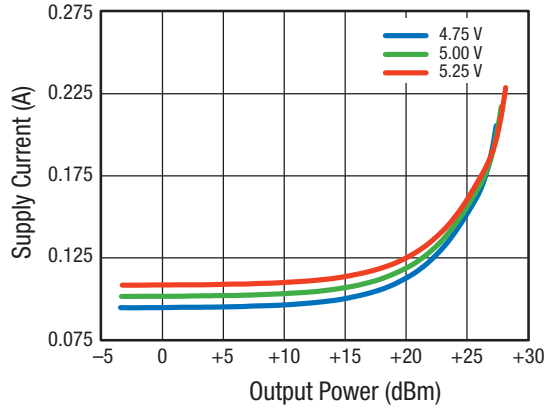

Figure 62. Supply Current vs Output Power Across VCC

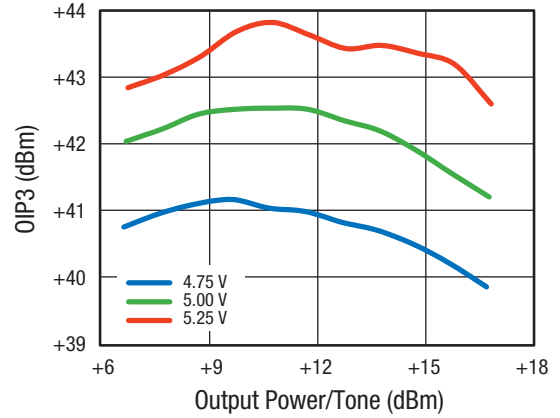

Figure 63. OIP3 vs Output Power/Tone Across VCC

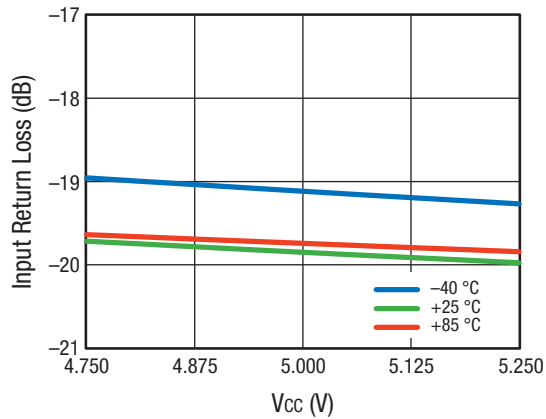

Figure 64. Input Return Loss vs VCC Across Temperature

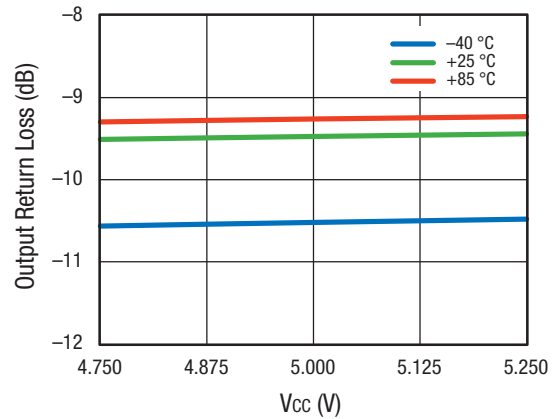

Figure 65. Output Return Loss vs VCC Across Temperature

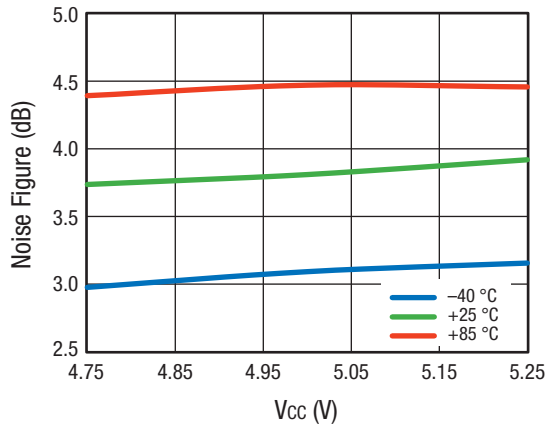

Figure 66. Noise Figure vs VCC Across Temperature

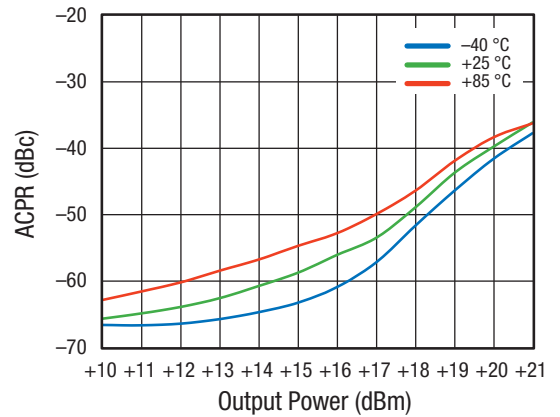
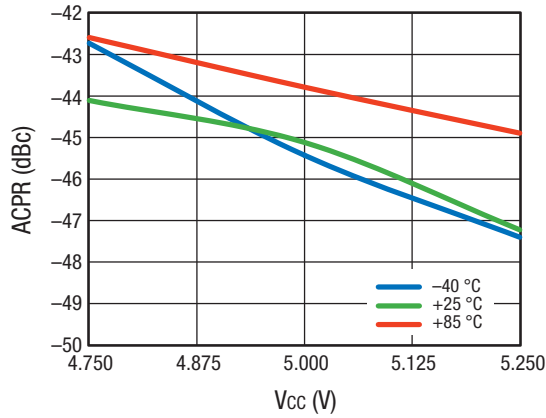
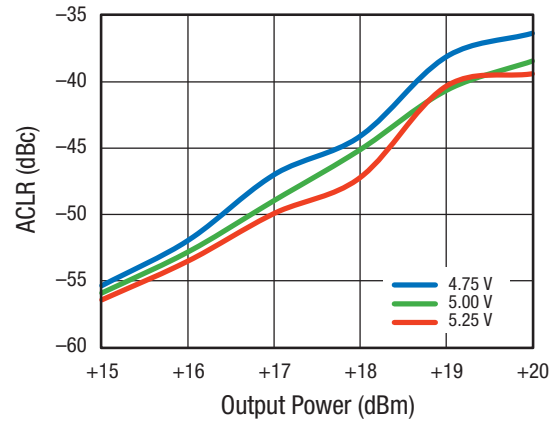

Figure 67. ACPR vs Output Power Across Temperature



**Figure 68. ACPR vs VCC Across Temperature**  
Output Power = +18 dBm



**Figure 69. ACLR vs Output Power Across VCC**

### Typical Performance Data

(VCC = 5 V, f = 2450 MHz, CW, Output Impedance = 50 Ω, Tc = 25 °C, Unless Otherwise Noted)

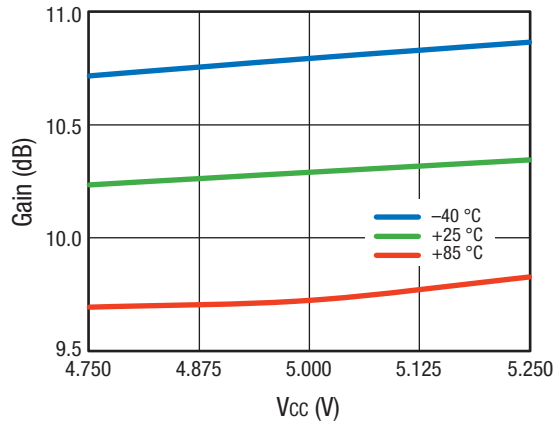

**Figure 70. Gain vs VCC Across Temperature**  
Input Power = -15 dBm

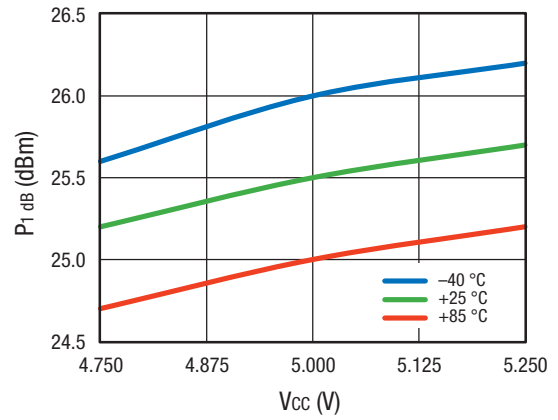

**Figure 71. P1 dB vs VCC Across Temperature**

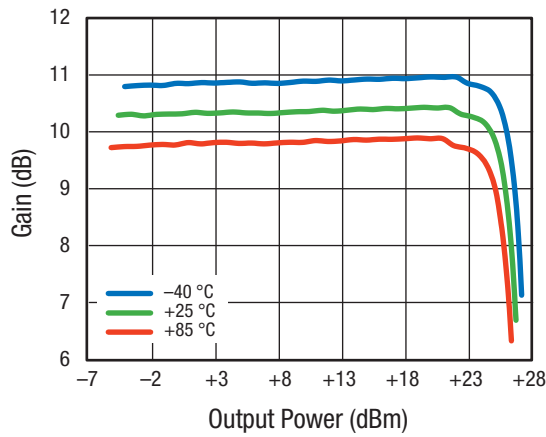

**Figure 72. Gain vs Output Power Across Temperature**

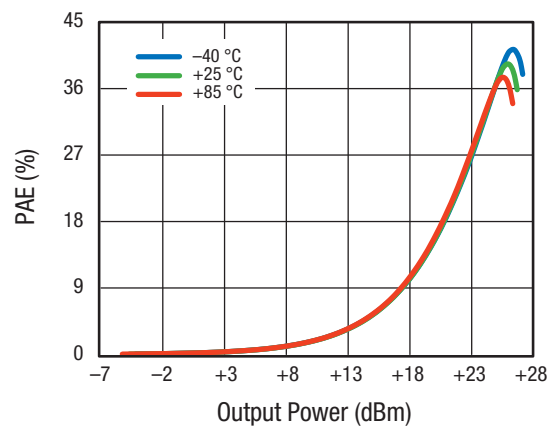

**Figure 73. PAE vs Output Power Across Temperature**

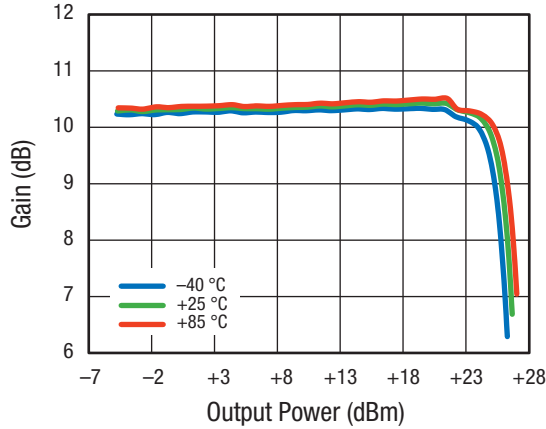

Figure 74. Gain vs Output Power Across VCC

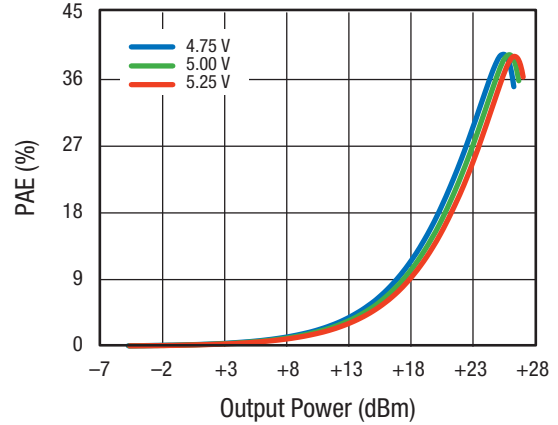

Figure 75. PAE vs Output Power Across VCC

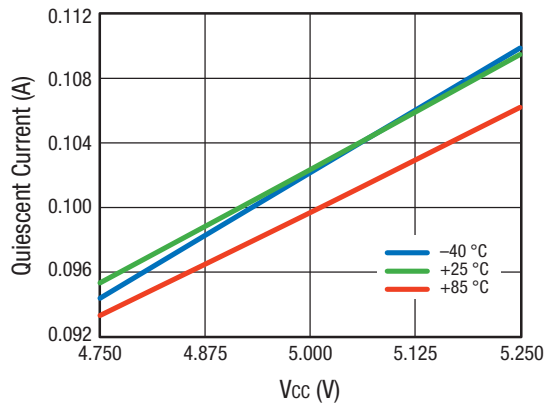

Figure 76. Quiescent Current vs VCC Across Temperature

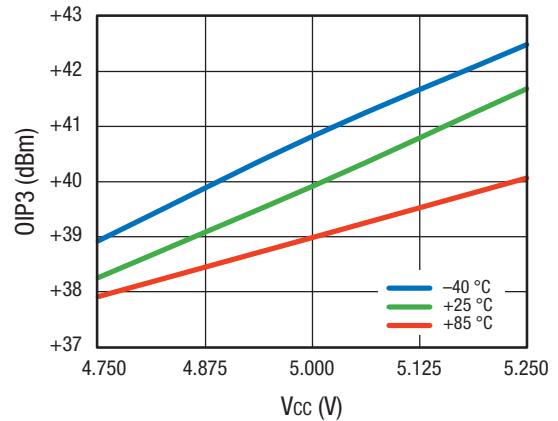

Figure 77. OIP3 vs VCC Across Temperature  
Input Power/Tone = 0 dBm

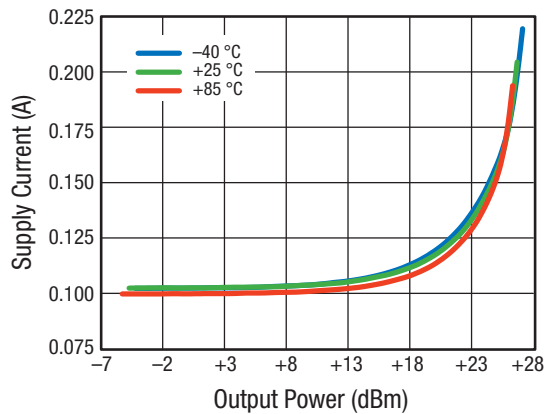

Figure 78. Supply Current vs Output Power Across Temperature

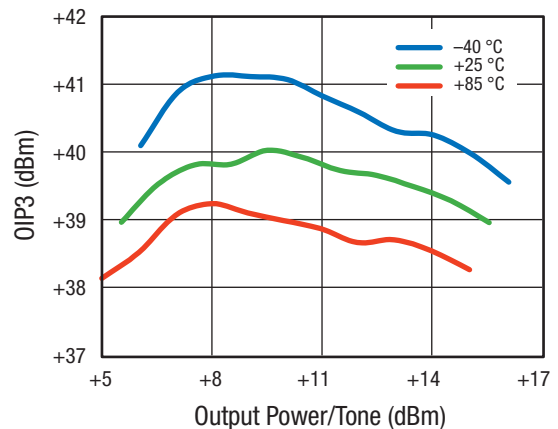

Figure 79. OIP3 vs Output Power/Tone Across Temperature

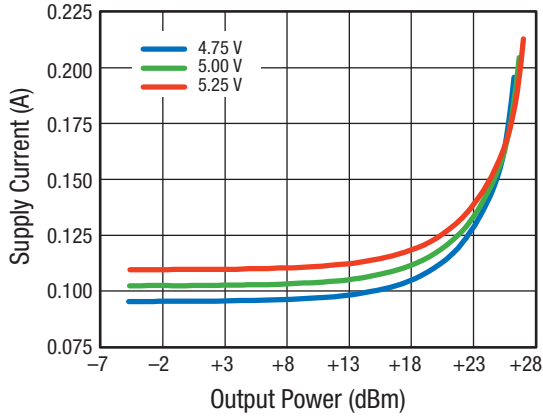

Figure 80. Supply Current vs Output Power Across VCC

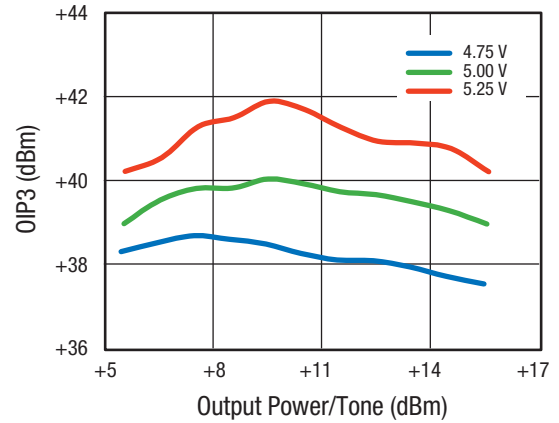

Figure 81. OIP3 vs Output Power/Tone Across VCC

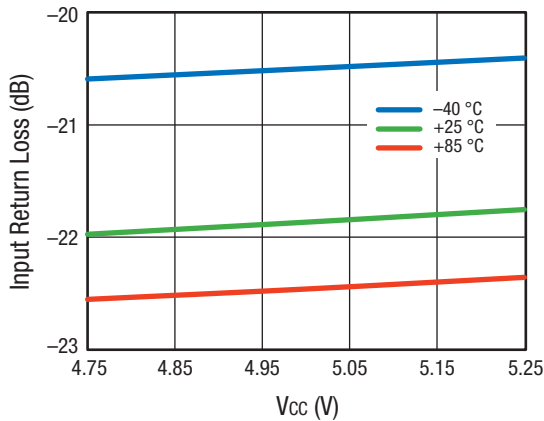

Figure 82. Input Return Loss vs VCC Across Temperature

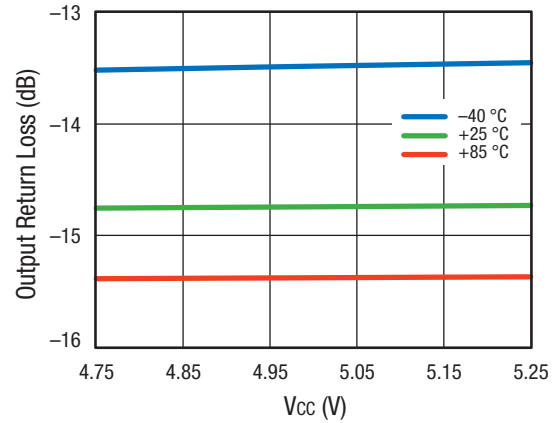

Figure 83. Output Return Loss vs VCC Across Temperature

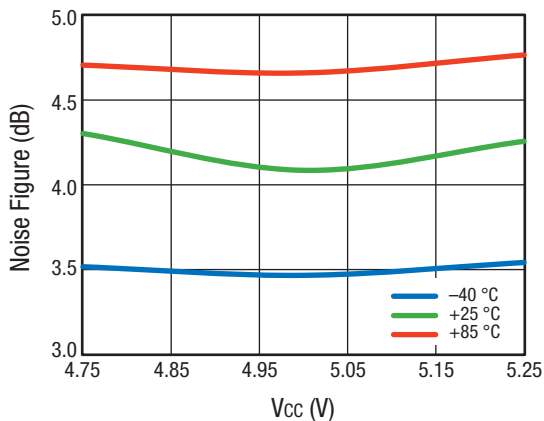

Figure 84. Noise Figure vs. VCC Across Temperature

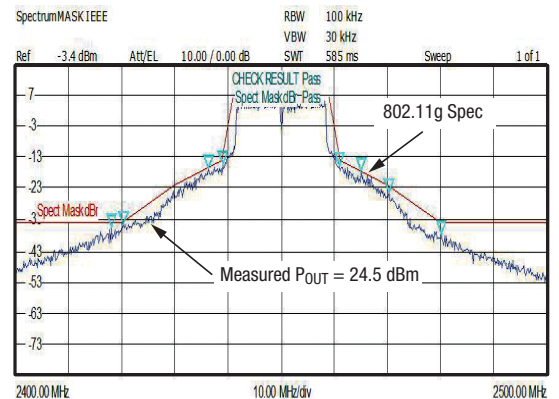
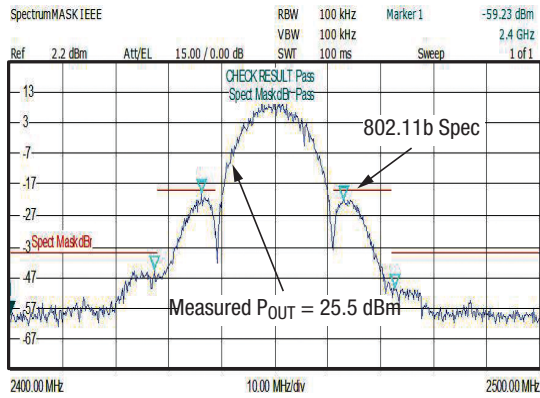
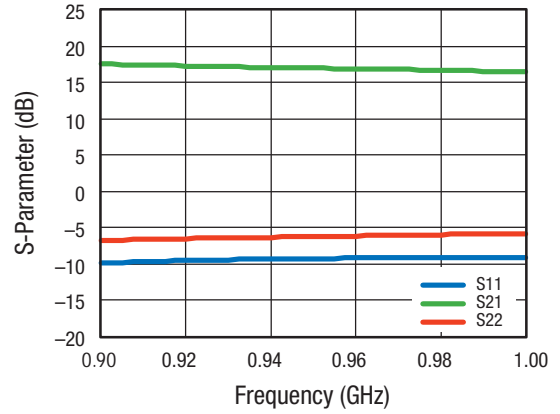

Figure 85. Spectral Response (802.11g 64 QAM at 54 Mbps Input Signal)

**DATA SHEET • SKY65009-70LF: LINEAR PA DRIVER**



**Figure 86. . Spectral Response  
(802.11b 64 CCK at 11 Mbps Input Signal)**

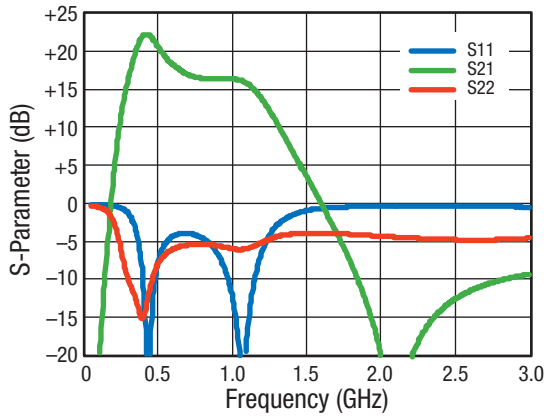

**Figure 87. S-Parameter vs Frequency T = 25°C  
Tuned for 900 MHz**



**Typical Performance Data**

(VCC = 5 V, MHz, CW, Output Impedance = 50 Ω, Tc = 25 °C, Unless Otherwise Noted)



**Figure 88. S-Parameter vs Frequency, Tuned for 450 MHz**

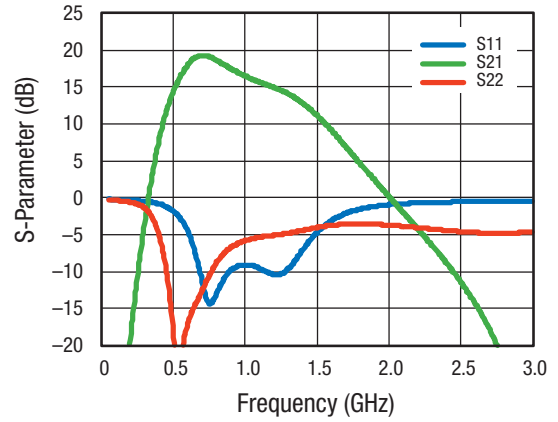

**Figure 89. S-Parameter vs Frequency, Tuned for 900 MHz**

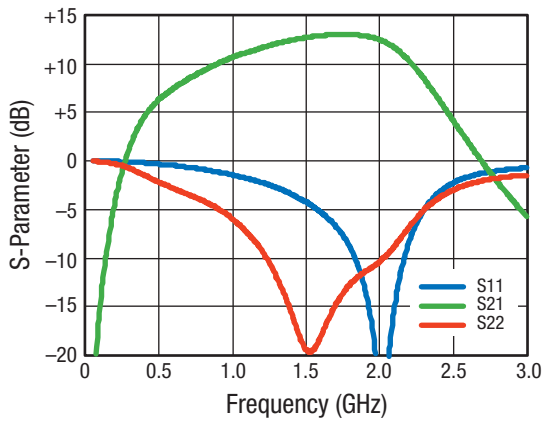

**Figure 90. S-Parameter vs Frequency, Tuned for 1960 MHz**

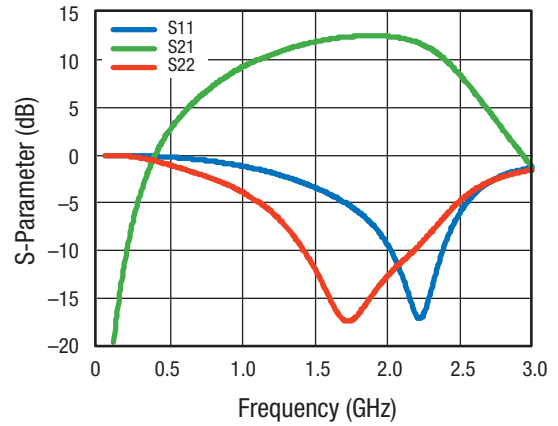

**Figure 91. S-Parameter vs Frequency, Tuned for 2140 MHz**

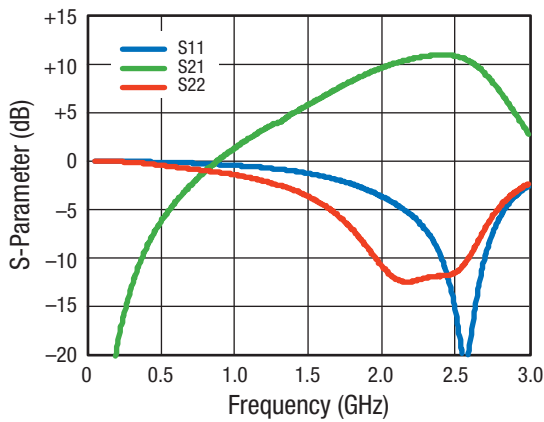

**Figure 92. S-Parameters vs Frequency, Tuned for 2450 MHz**

## Evaluation Board Description

The Skyworks SKY65009 Evaluation Board is used to test the performance of the SKY65009-70LF PA driver. The Evaluation Board schematic diagram is shown in Figure 93, and component values vs. frequency information is shown in Table 5. An assembly drawing for the Evaluation Board is shown in Figure 94, and the layer detail is provided in Figure 95. The layer detail physical characteristics are noted in Figure 96.

The Evaluation Board Bill of Materials (BOM) is shown in Table 6. The board layout footprint, package marking, and package dimensions for the 4-pin SOT-89 are shown in Figures 97 through 99. Tape and reel dimensions are shown in Figure 100.

## Circuit Design Configurations

The following design considerations are general in nature and must be followed regardless of final use or configuration:

1. Paths to ground should be made as short as possible.
2. The ground pad of the SKY65009-70LF has special electrical and thermal grounding requirements. This pad is the main thermal conduit for heat dissipation. Since the circuit board acts as the heat sink, it must shunt as much heat as possible from the device. Therefore, design the connection to the ground pad to dissipate the maximum wattage produced by the circuit board. Multiple vias to the grounding layer are required.
3. Skyworks recommends including external bypass capacitors on the DC supply lines. An RF inductor is required on the VCC supply line to block RF signals from the DC supply. Refer to Figure 93 for more detail.
4. The RF lines should be well separated from each other with solid ground in between traces to maximize input-to-output isolation.

**NOTE:** Junction temperature ( $T_j$ ) of the device increases with a poor connection to the ground pad and ground. This reduces the lifetime of the device.

## Application Circuit Notes

**RF\_IN (pin 1):** The amplifier requires a DC blocking capacitor as part of the external RF matching.

**GND (pin 2):** Attach the ground pin to the RF ground plane with the largest diameter and lowest inductance via that the layout allows. Multiple small vias are also acceptable and work well under the device if solder migration is an issue.

**RF\_OUT (pin 3):** The amplifier requires a DC blocking capacitor as part of the external RF matching. The amplifier collector supply voltage is supplied through an RF choke to the output at pin 3.

**GND (pin 4):** It is extremely important that the device paddle be sufficiently grounded for both thermal and stability reasons. Multiple small vias are acceptable and work well under the device if solder migration is an issue.

## Testing Procedure

Use the following procedure to set up the SKY65009 Evaluation Board for testing:

1. Connect a 5 V supply to VCC. If available, enable the current limiting function of the power supply to 300 mA.
2. Connect a signal generator to the RF signal input port. Set it to the desired RF frequency at a power level of  $-15$  dBm or less to the Evaluation Board but do NOT enable the RF signal.
3. Connect a spectrum analyzer to the RF signal output port.
4. Enable the power supply.
5. Enable the RF signal.
6. Take measurements.

---

**CAUTION:** If the input signal exceeds the rated maximum values, the SKY65009 Evaluation Board can be permanently damaged.

---

**NOTE:** It is important to adjust the VCC voltage source so that  $+5$  V is measured at the board. The high collector currents drop the collector voltage significantly if long leads are used. Adjust the bias voltage to compensate.

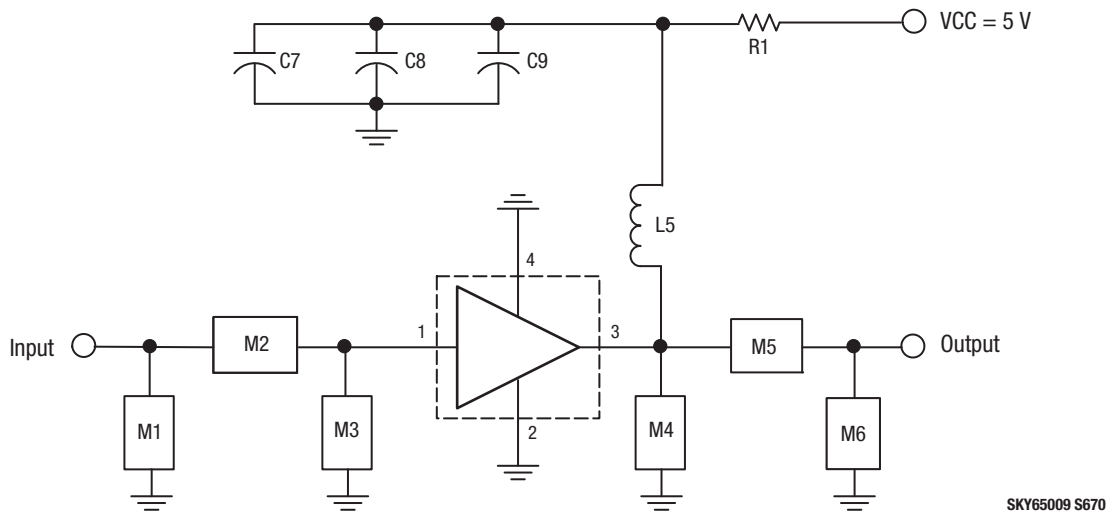
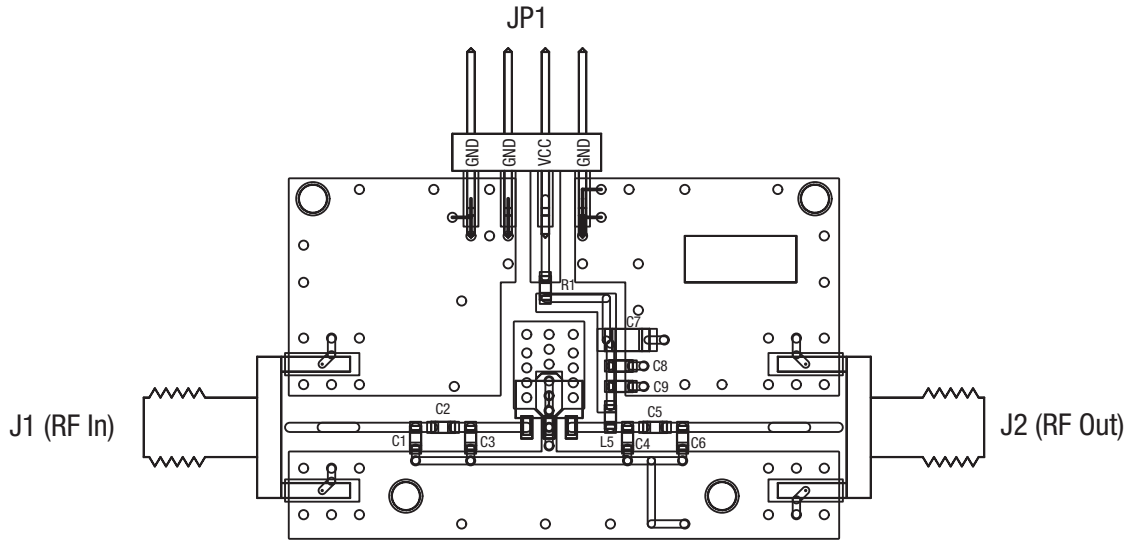

**Figure 93. SKY65009 Evaluation Board Schematic**  
(Refer to Tables 5 and 6 for Component Values)

SKY65009 S670

**Table 5. Evaluation Board Component Values vs Frequency**

Component	450 MHz	900 MHz	1960 MHz (OIP3)	1960 MHz (ACPR)	2140 MHz	2450 MHz
R1	0 Ω	0 Ω	0 Ω	0 Ω	0 Ω	0 Ω
C7	1 μF	1 μF	1 μF	1 μF	1 μF	1 μF
C8	1000 pF	1000 pF	1000 pF	1000 pF	1000 pF	1000 pF
C9	68 pF	68 pF	18 pF	18 pF	18 pF	15 pF
L5	47 nH	47 nH	27 nH	22 nH	22 nH	22 nH
M1	8.2 nH	8.2 nH	1.8 nH	1.2 pF	1.2 pF	1 pF
M2	12 pF	4.7 pF	2.7 pF	2.2 pF	2.2 pF	1.2 pF
M3	6.8 pF	4.7 pF	DNC	DNC	DNC	DNC
M4	DNC	DNC	1.2 pF	1.2 pF	1.2 pF	DNC
M5	12 pF	6.8 pF	5.6 pF	3.3 pF	3.3 pF	2.2 pF
M6	27 nH	12 nH	1.0 pF	0.5 pF	0.5 pF	1.2 pF



S708

Figure 94. SKY65009 Evaluation Board Assembly Drawing

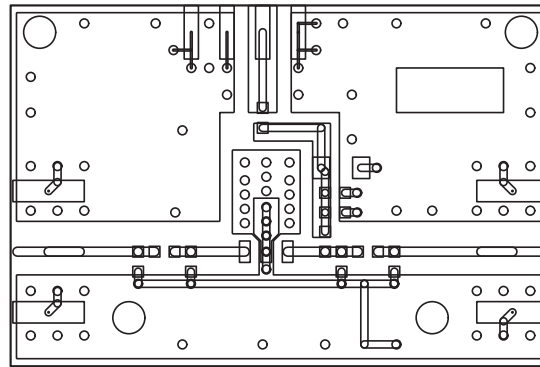

Layer 1: Top - Metal

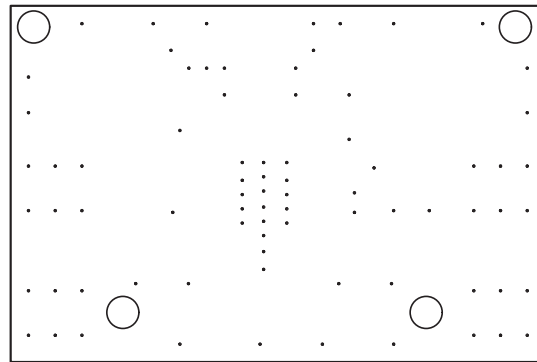

Layer 2: Ground

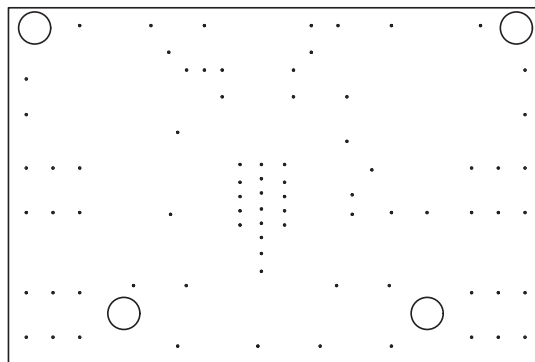

Layer 3: Ground

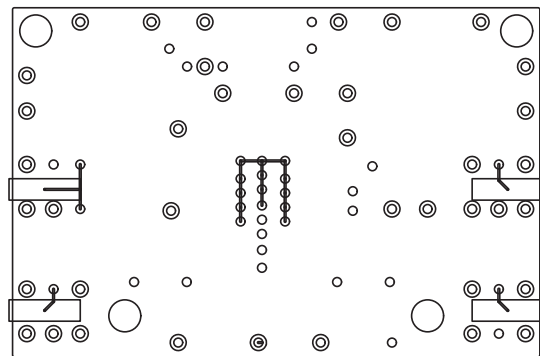

Layer 4: Solid Ground Plane

S709

**Figure 95. Evaluation Board Layer Detail**

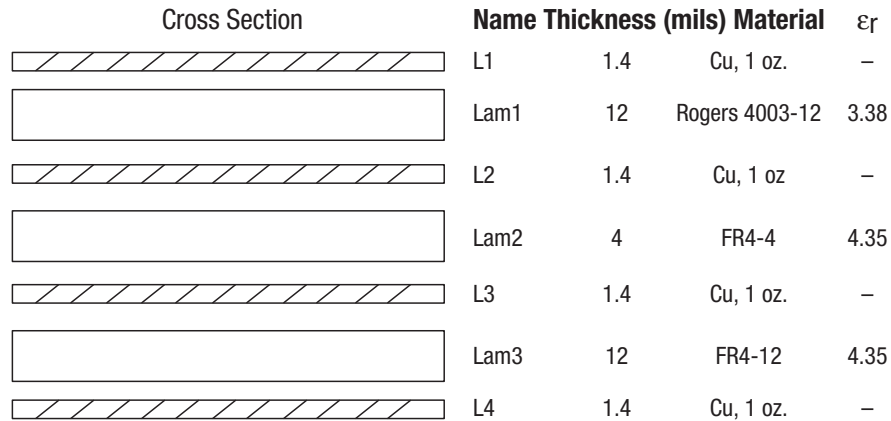

SKY65009-S573

Figure 96. Layer Detail Physical Characteristics

Table 6. SKY65009 Evaluation Board Bill of Materials

Part	Size	Value	Product Number	Manufacturer	Mfr Part Number	Characteristics
1	0603	8.2 nH	5332R34-018	Taiyo-Yuden	HK16088N2J-T	±5%, SRF 3500 MHz
2	0603	12 nH	5332R34-022	Taiyo-Yuden	HK160812NJ-T	±5%, SRF 2600 MHz
3	0603	22 nH	5332R34-028	Taiyo-Yuden	HK160822NJ-T	±5%, SRF 1600 MHz
4	0603	27 nH	5332R34-030	Taiyo-Yuden	HK160827NJ-T	±5%, SRF 1400 MHz
5	0603	47 nH	5332R34-036	Taiyo-Yuden	HK160847NJ-T	±5%, SRF 900 MHz
6	0603	0.5 pF	5404R98-001	Murata	GRM1885C1HR50CZ01D	COG, 50 V, ± 0.25 pF
7	0603	1 pF	5404R23-035	Murata	GRM1885C1H1R0CZ01D	COG, 50 V, ± 0.25 pF
8	0603	1.2 pF	5404R23-036	Murata	GRM1885C1H1R2CD27J	COG, 50 V, ± 0.25 pF
9	0603	1.8 pF	5404R23-038	Murata	GRM1885C1H1R8CZ01J	COG, 50 V, ± 0.25 pF
10	0603	2.2 pF	5404R23-039	Murata	GRM1885C1H2R2CZ01D	COG, 50 V, ± 0.25 pF
11	0603	2.7 pF	5404R23-040	Murata	GRM1885C1H2R7CZ01D	COG, 50 V, ± 0.25 pF
12	0603	3.3 pF	5404R23-041	Murata	GRM1885C1H3R3CZ01D	COG, 50 V, ± 0.25 pF
13	0805	4.7 pF	5404R98-006	Murata	GRM1885C1H4R7CZ01D	COG, 50 V, ± 0.25 pF
14	0603	5.6 pF	5404R23-010	Murata	GRM1885C1H5R6DZ01D	COG, 50 V, ± 0.25 pF
15	0603	6.8 pF	5404R23-045	Murata	GRM1885C1H6R8CD01J	COG, 50 V, ± 0.25 pF
16	0603	12 pF	5404R23-014	Murata	GRM1885C1H120JD51D	COG, 50 V, ± 5%
17	0603	15 pF	5404R23-015	Murata	GRM1885C1H150JD51D	COG, 50 V, ± 5%
18	0603	18 pF	5404R23-016	Murata	GRM1885C1H180JD51D	COG, 50 V, ± 5%
19	0603	68 pF	5404R23-023	Murata	GRM1885C1H680JD51D	COG, 50 V, ± 5%
20	0603	1000 pF	5404R23-057	TDK	C1608C0G1H102JT	COG, 50 V, ± 5%
21	0805	1 μF	5404R29-070	TDK	C2012X7R1H104K	X7R, 50 V, ± 10%
22	0603	0 Ω	5424R20-146	Rohm	MCR03EZJH000	50 V, 0.063 W, ± 5%

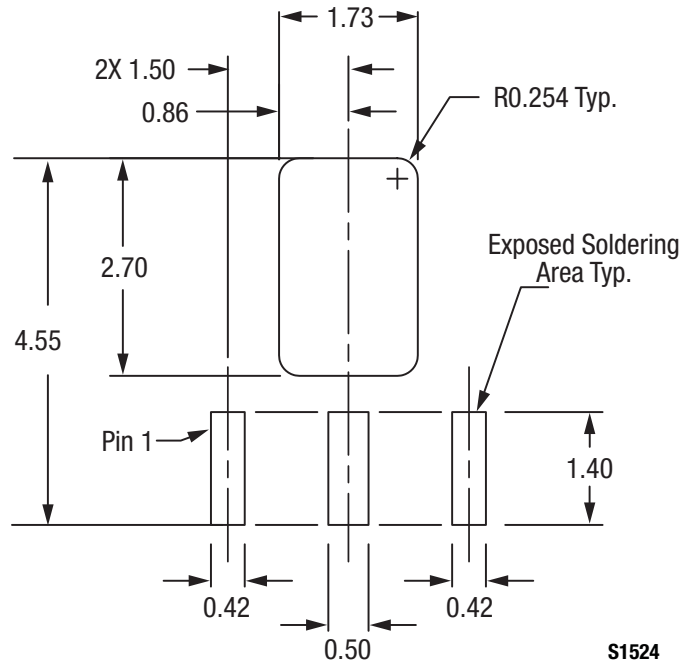

**Figure 97. SKY65009-70LF Board Layout Footprint**

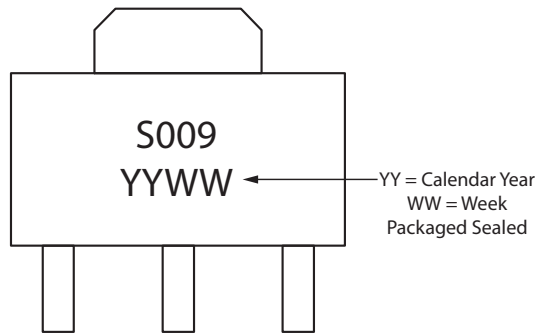

**Figure 98. Typical Package Marking**

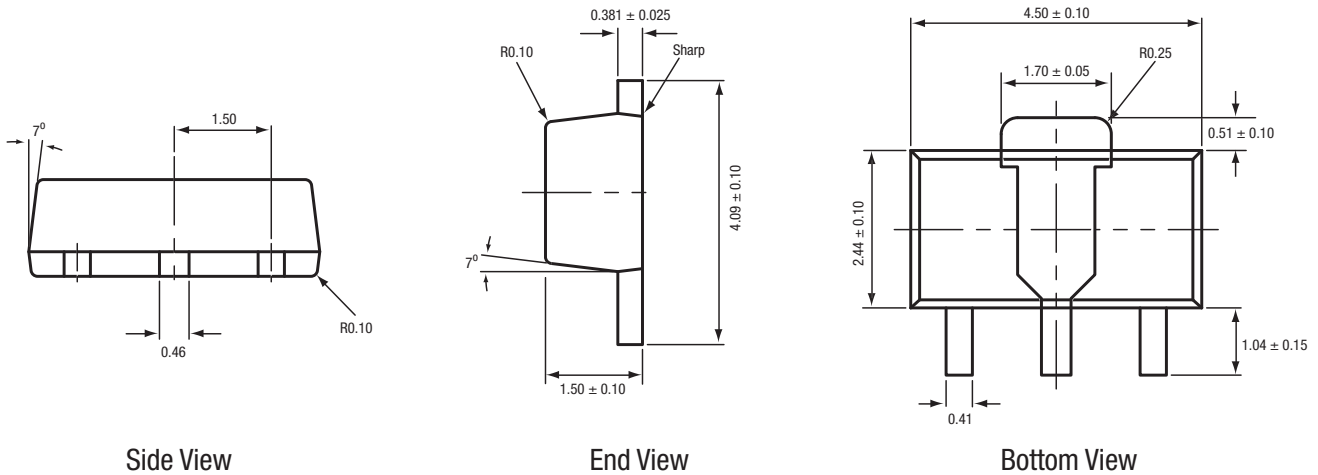

All measurements are in millimeters

S253

Figure 99. SKY65009 SOT-89 Package Dimensions

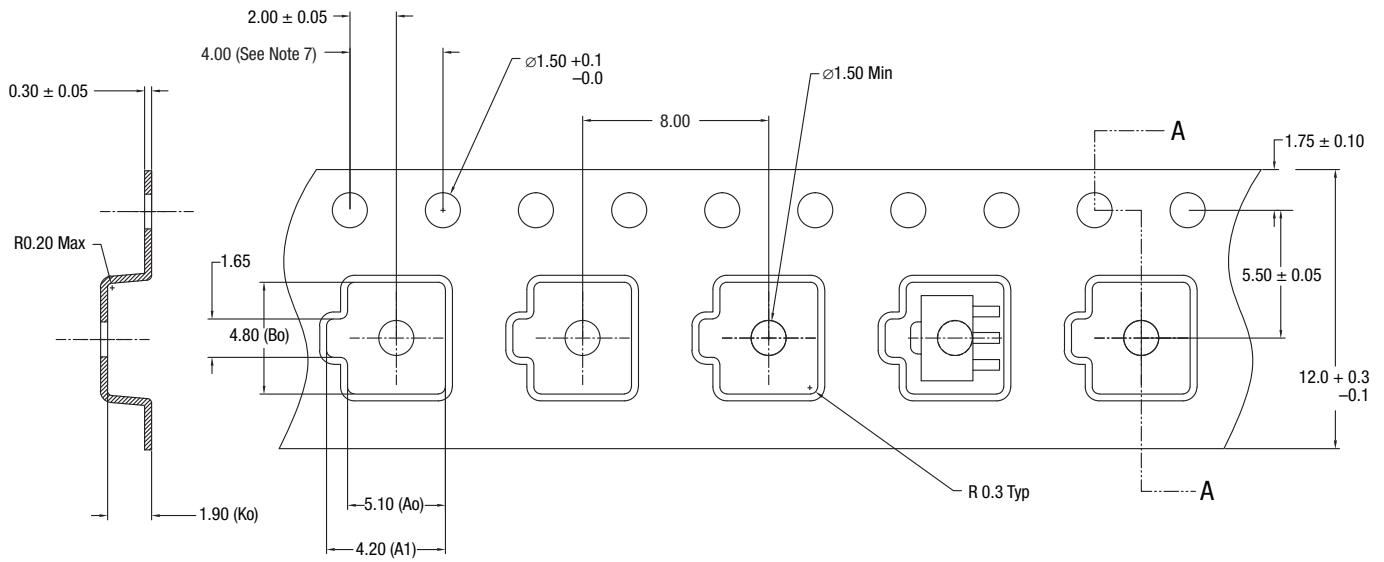

Notes:

1. Carrier tapes must meet all requirements of Skyworks GP01-D233 procurement spec for tape and reel shipping.
2. Carrier tape material: black conductive polycarbonate or polystyrene.
3. Cover tape material: transparent conductive PSA.  
Cover tape size: 9.2 mm width.
4. Typical ESD surface resistivity must meet all ESD requirements of Skyworks specified in GP01-D233.
5. Ao and Bo measurement point to be 0.30 mm from bottom pocket.
6. All measurements are in millimeters.
7. 10-sprocket hole pitch cumulative tolerance 0.2 mm.

200953-100

Figure 100. SKY65009 SOT-89 Tape and Reel Dimensions



## Ordering Information

Model Name	Ordering Part Number	Evaluation Board Part Number
SKY65009-70LF: 250-2500 MHz Linear PA Driver	SKY65009-70LF	TW13-D281-101 (450 MHz) TW13-D282-101 (900 MHz) TW13-D283-101 (1960 MHz – OIP3) TW13-D284-101 (1960 MHz - ACPR) TW13-D285-101 (2140 MHz) TW13-D286-101 (2450 MHz)

Copyright © 2002-2009, 2013, 2016 Skyworks Solutions, Inc. All Rights Reserved.

Information in this document is provided in connection with Skyworks Solutions, Inc. (“Skyworks”) products or services. These materials, including the information contained herein, are provided by Skyworks as a service to its customers and may be used for informational purposes only by the customer. Skyworks assumes no responsibility for errors or omissions in these materials or the information contained herein. Skyworks may change its documentation, products, services, specifications or product descriptions at any time, without notice. Skyworks makes no commitment to update the materials or information and shall have no responsibility whatsoever for conflicts, incompatibilities, or other difficulties arising from any future changes.

No license, whether express, implied, by estoppel or otherwise, is granted to any intellectual property rights by this document. Skyworks assumes no liability for any materials, products or information provided hereunder, including the sale, distribution, reproduction or use of Skyworks products, information or materials, except as may be provided in Skyworks Terms and Conditions of Sale.

THE MATERIALS, PRODUCTS AND INFORMATION ARE PROVIDED “AS IS” WITHOUT WARRANTY OF ANY KIND, WHETHER EXPRESS, IMPLIED, STATUTORY, OR OTHERWISE, INCLUDING FITNESS FOR A PARTICULAR PURPOSE OR USE, MERCHANTABILITY, PERFORMANCE, QUALITY OR NON-INFRINGEMENT OF ANY INTELLECTUAL PROPERTY RIGHT; ALL SUCH WARRANTIES ARE HEREBY EXPRESSLY DISCLAIMED. SKYWORKS DOES NOT WARRANT THE ACCURACY OR COMPLETENESS OF THE INFORMATION, TEXT, GRAPHICS OR OTHER ITEMS CONTAINED WITHIN THESE MATERIALS. SKYWORKS SHALL NOT BE LIABLE FOR ANY DAMAGES, INCLUDING BUT NOT LIMITED TO ANY SPECIAL, INDIRECT, INCIDENTAL, STATUTORY, OR CONSEQUENTIAL DAMAGES, INCLUDING WITHOUT LIMITATION, LOST REVENUES OR LOST PROFITS THAT MAY RESULT FROM THE USE OF THE MATERIALS OR INFORMATION, WHETHER OR NOT THE RECIPIENT OF MATERIALS HAS BEEN ADVISED OF THE POSSIBILITY OF SUCH DAMAGE.

Skyworks products are not intended for use in medical, lifesaving or life-sustaining applications, or other equipment in which the failure of the Skyworks products could lead to personal injury, death, physical or environmental damage. Skyworks customers using or selling Skyworks products for use in such applications do so at their own risk and agree to fully indemnify Skyworks for any damages resulting from such improper use or sale.

Customers are responsible for their products and applications using Skyworks products, which may deviate from published specifications as a result of design defects, errors, or operation of products outside of published parameters or design specifications. Customers should include design and operating safeguards to minimize these and other risks. Skyworks assumes no liability for applications assistance, customer product design, or damage to any equipment resulting from the use of Skyworks products outside of stated published specifications or parameters.

Skyworks and the Skyworks symbol are trademarks or registered trademarks of Skyworks Solutions, Inc., in the United States and other countries. Third-party brands and names are for identification purposes only, and are the property of their respective owners. Additional information, including relevant terms and conditions, posted at [www.skyworksinc.com](http://www.skyworksinc.com), are incorporated by reference.