

2-INPUT 3CHANNEL VIDEO SWITCH

■ GENERAL DESCRIPTION

NJM2285 is a switching IC for switching over from one audio or video input signal to another. Internalizing 2 inputs, 1 output, and then each set of 3 can be operated independently. Two of them are Clamp type", and they can be operated while setting DC level fixed in position of the video signal. It is a higher efficiency video switch, featuring the operating supply voltage 5 to 12V, the frequency feature 10MHz, and then the crosstalk 75dB (at 4.43MHz).

■ PACKAGE OUTLINE

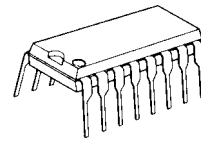

NJM2285D

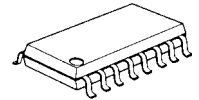

NJM2285M

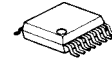

NJM2285V

■ FEATURES

- 2 Input-1 Output
Internalizing 3 Circuits (Two of them are Clamp type).
- Wide Operating Supply Voltage (4.75 to 13.0V)
- Crosstalk 75dB (at 4.43MHz)
- Wide Bandwidth Frequency Feature 10MHz (2V_{P-P} Input)
- Package Outline DIP16, DMP16, SSOP16
- Bipolar Technology

■ APPLICATIONS

- VCR, Video Camera, AV-TV, Video Disk Player.

■ BLOCK DIAGRAM

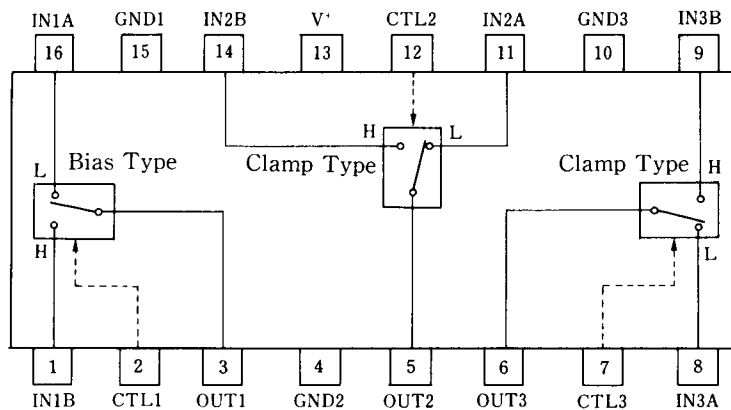

NJM2285D
NJM2285M
NJM2285V

NJM2285

■ MAXIMUM RATINGS

(T_a = 25°C)

PARAMETER	SYMBOL	RATINGS	UNIT
Supply Voltage	V ⁺	14	V
Power Dissipation	P _D	(DIP16) 700 (DMP16) 350 (SSOP16) 300	mW mW mW
Operating Temperature Range	T _{opr}	-40 to +85	°C
Storage Temperature Range	T _{stg}	-40 to +125	°C

■ ELECTRICAL CHARACTERISTICS

(V⁺ = 5V, T_a = 25°C)

PARAMETER	SYMBOL	TEST CONDITION	MIN.	TYP.	MAX.	UNIT
Operating Current (1)	I _{CC1}	V ⁺ = 5V (Note1)	8.0	11.4	14.8	mA
Operating Current (2)	I _{CC2}	V ⁺ = 9V (Note1)	10.0	14.3	18.6	mA
Voltage Gain	G _V	V _I = 100kHz, 2V _{P,P} , V _O / V _I	-0.6	-0.1	+0.4	dB
Frequency Gain	G _F	V _I = 2V _{P,P} , V _O (10MHz) / V _O (100kHz)	-1.0	0	+1.0	dB
Differential Gain	DG	V _I = 2V _{P,P} , Standard Staircase Signal	-	0.3	-	%
Differential Phasa	DP	V _I = 2V _{P,P} , Standard Staircase Signal	-	0.3	-	deg
Output Offset Voltage	V _{OS}	(Note2)	-10	0	+10	mV
Crosstalk	CT	V _I = 2V _{P,P} , 4.43MHz, V _O / V _I	-	-75	-	dB
Switch Change Over Voltage	V _{CH}	All inside Switches ON	2.5	-	-	V
Switch Change Over Voltage	V _{CL}	All inside Switches OFF	-	-	1.0	V

(Note1) S1 = S2 = S3 = S4 = S5 = S6 = S7 = 1

(Note2) S1 = S2 = S3 = S4 = S5 = S6 = 1, S7 = 1→2 Measure the output DC voltage difference

■ TERMINAL EXPLANATION

PIN No.	PIN NAME	VOLTAGE	INSIDE EQUIVALENT CIRCUIT
16 1	IN 1 A IN 1 B [Input]	2.5V	
11 14 8 9	IN 2 A IN 2 B IN 3 A IN 3 B [Input]	1.5V	
2 12 7	CTL 1 CTL 2 CTL 3 [Switching]		
3	OUT1	1.8V	
5 6	OUT2 OUT3 [Output]	0.8V	
13	V ⁺	5V	
15 4 10	GND 1 GND 2 GND 3		

NJM2285

TEST CIRCUIT

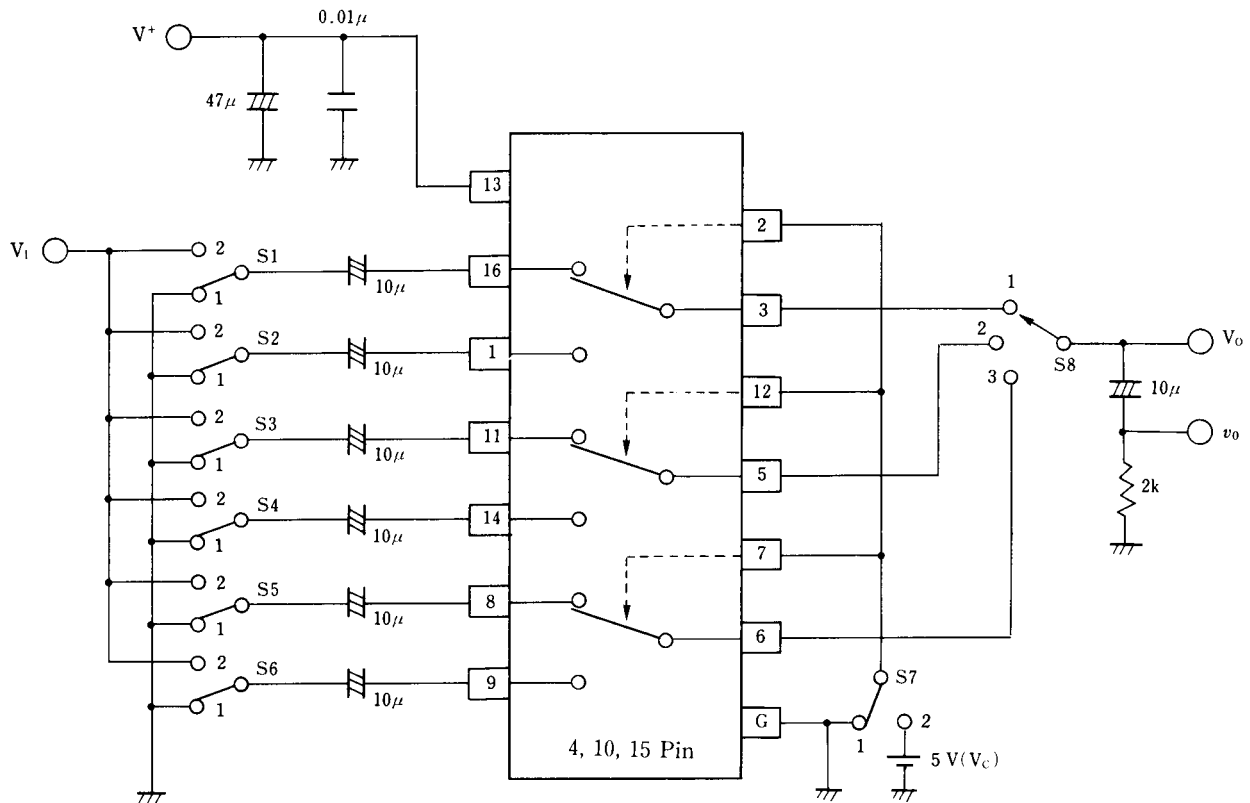

This IC requires 1MΩ resistance between INPUT and GND pin for clamp type input since the minute current causes an unstable pin voltage.

Parameter	S1	S2	S3	S4	S5	S6	S7	S8	Test Part
I_{CC1}	1	1	1	1	1	1	1	1	V^+
I_{CC2}	1	1	1	1	1	1	1	1	
G_{V1}	2	1	1	1	1	1	1	1	v_0
G_{F1}	2	1	1	1	1	1	1	1	
DG_1	2	1	1	1	1	1	1	1	
DP_1	2	1	1	1	1	1	1	1	
CT 1	2	1	1	1	1	1	2	1	v_0
CT 2	1	2	1	1	1	1	1	1	
CT 3	1	1	2	1	1	1	2	2	
CT 4	1	1	1	2	1	1	1	2	
CT 5	1	1	1	1	2	1	2	3	
CT 6	1	1	1	1	1	2	1	3	
V_{OS1}	1	1	1	1	1	1	1/2	1	V_O
V_{C1}	1/2	2/1	1	1	1	1	V_C	1	V_C
THD	2	1	1	1	1	1	1	1	v_0

■ TYPICAL CHARACTERISTICS

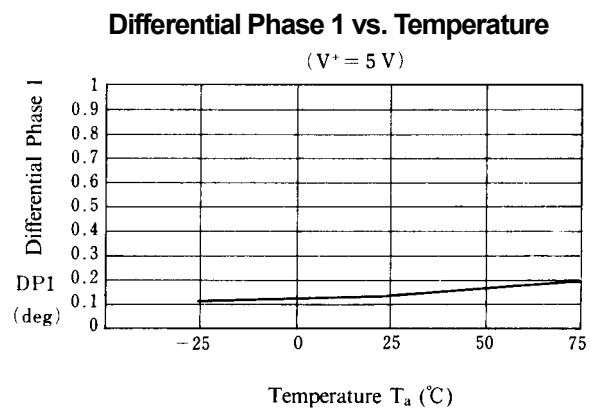
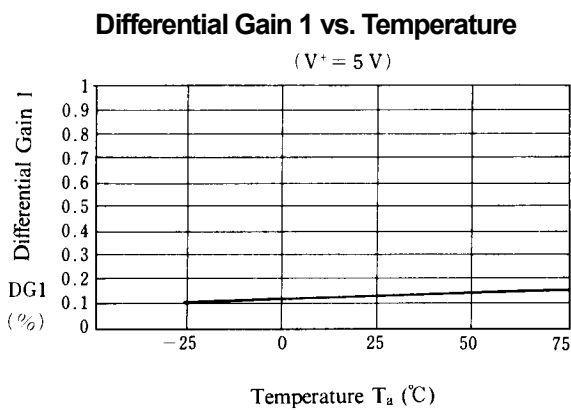
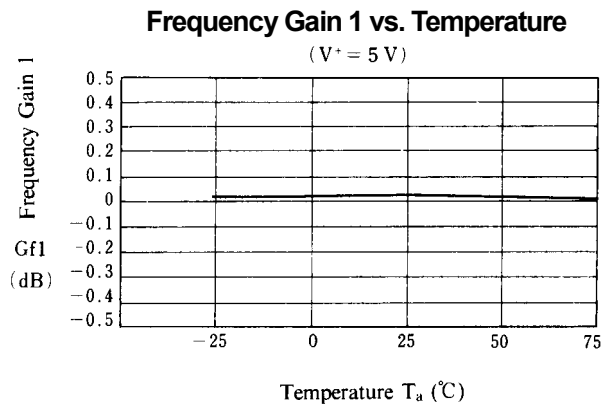
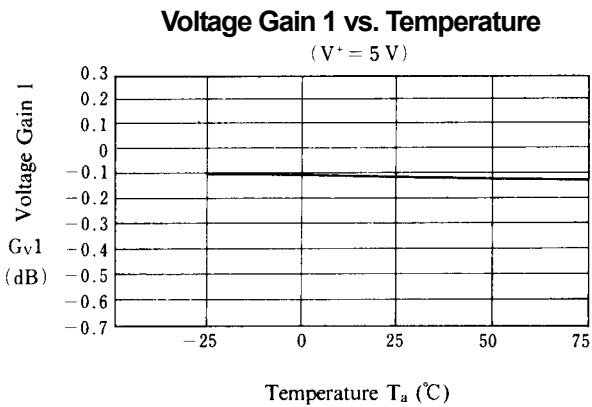
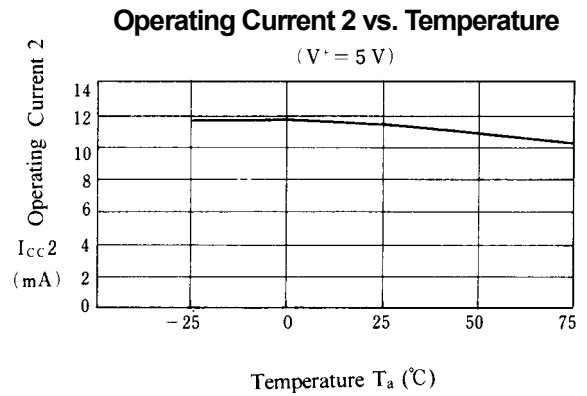
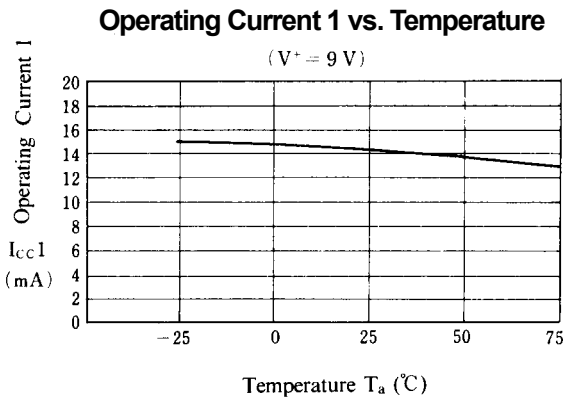

■ TYPICAL CHARACTERISTICS

Offset Voltage 1 vs. Temperature

($V^+ = 5\text{ V}$)

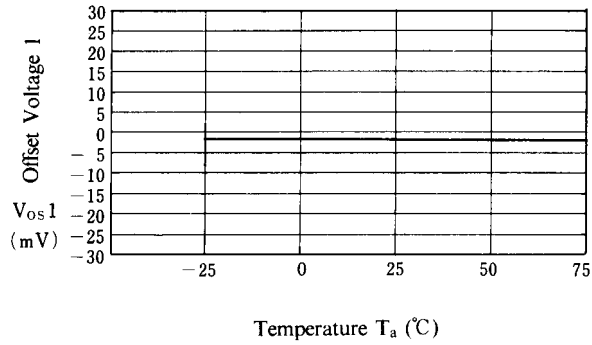

Crosstalk 1 vs. Temperature

($V^+ = 5\text{ V}$)

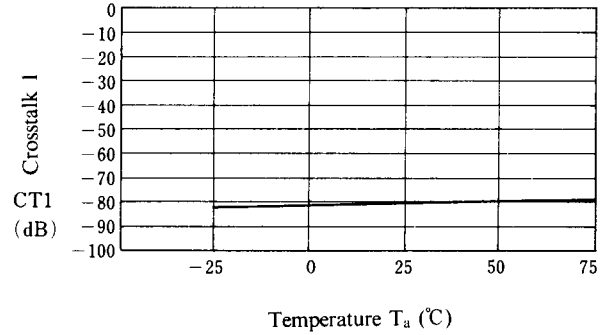

Crosstalk 2 vs. Temperature

($V^+ = 5\text{ V}$)

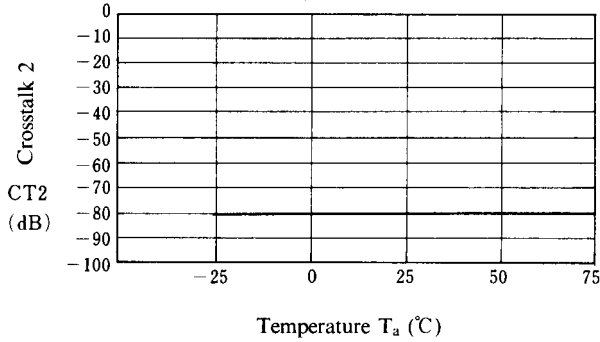

Crosstalk 3 vs. Temperature

($V^+ = 5\text{ V}$)

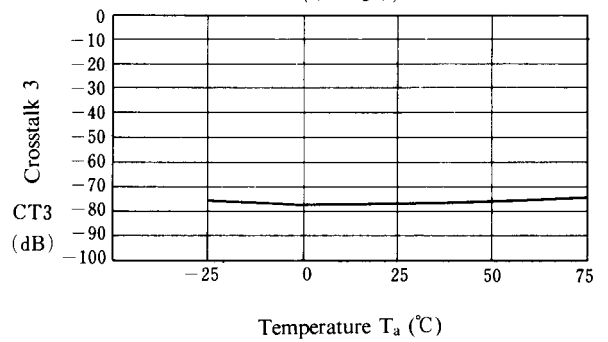

Crosstalk 4 vs. Temperature

($V^+ = 5\text{ V}$)

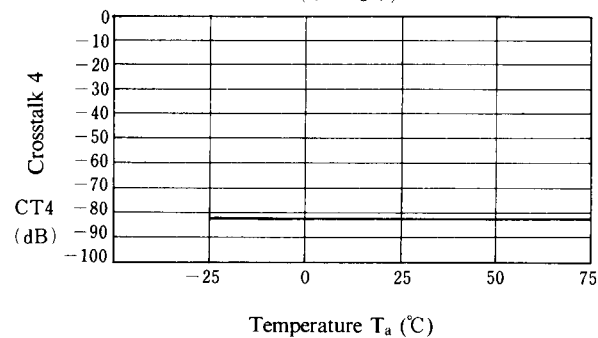

Crosstalk 5 vs. Temperature

($V^+ = 5\text{ V}$)

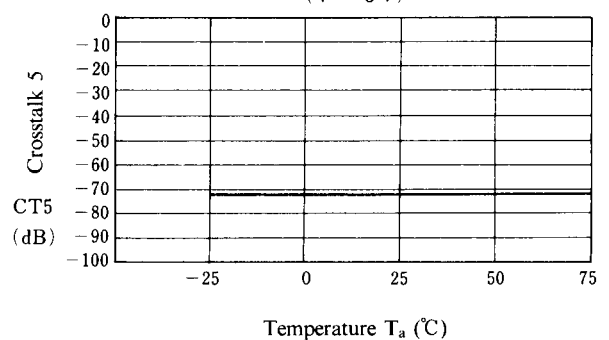

■ TYPICAL CHARACTERISTICS

Crosstalk 6 vs. Temperature
($V^+ = 5\text{ V}$)

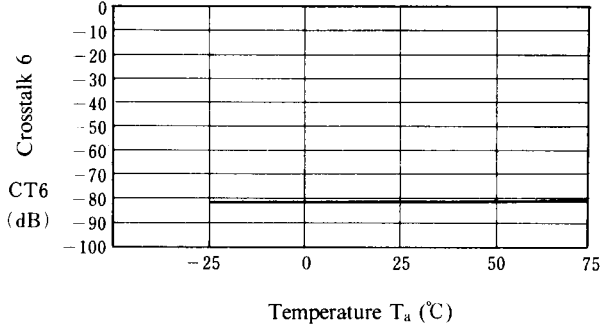

Switch Change Over 1 vs. Temperature
($V^+ = 5\text{ V}$)

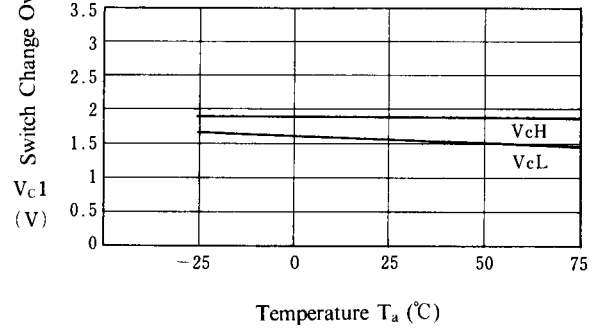

Supply Current 1 vs. Operating Voltage
($T_a = 25^\circ\text{C}$)

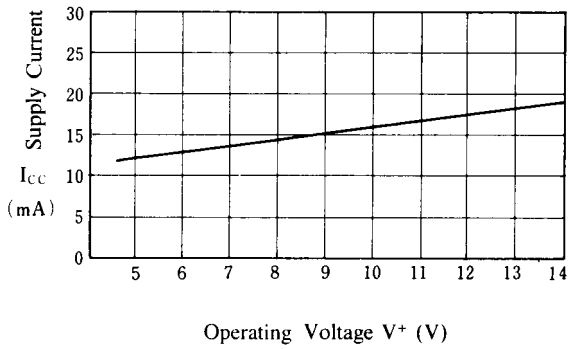

Voltage Gain 1 vs. Operating Voltage
($T_a = 25^\circ\text{C}$)

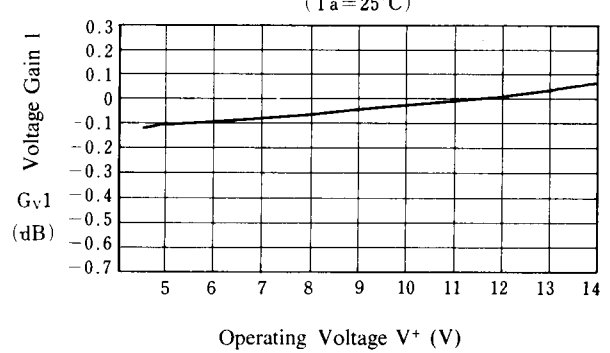

Frequency vs. Operating Voltage
($T_a = 25^\circ\text{C}$)

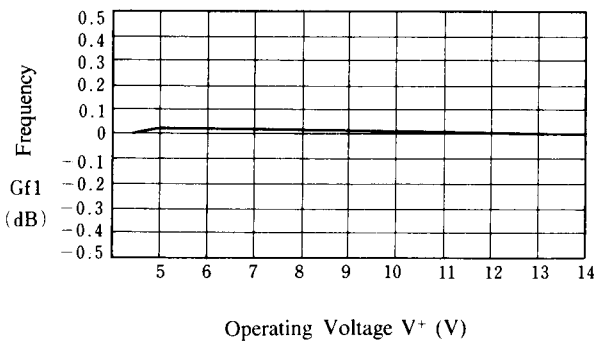

Differential Gain 1 vs. Operating Voltage
($T_a = 25^\circ\text{C}$)

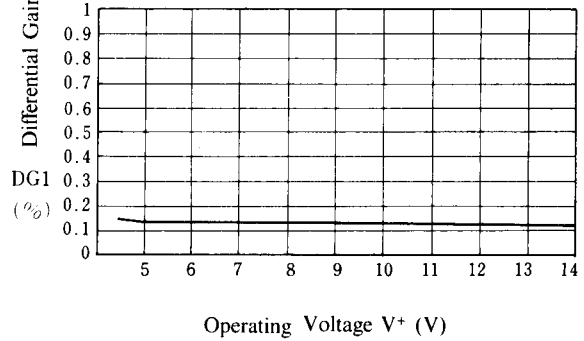

■ TYPICAL CHARACTERISTICS

Differential Phase 1 vs. Operating Voltage

($T_a = 25^\circ\text{C}$)

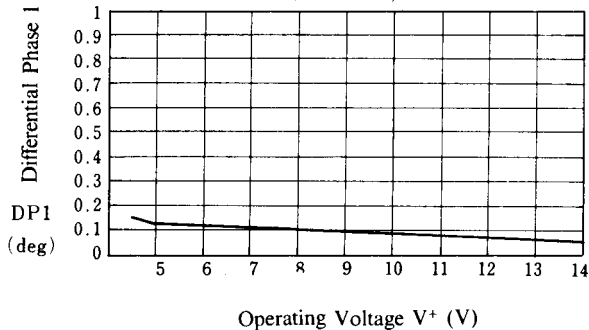

Offset Voltage 1 vs. Operating Voltage

($T_a = 25^\circ\text{C}$)

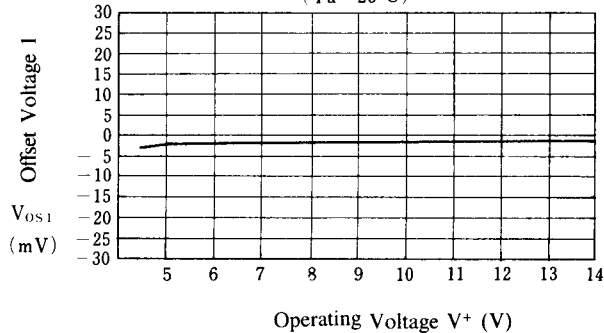

Crosstalk 1 vs. Operating Voltage

($T_a = 25^\circ\text{C}$)

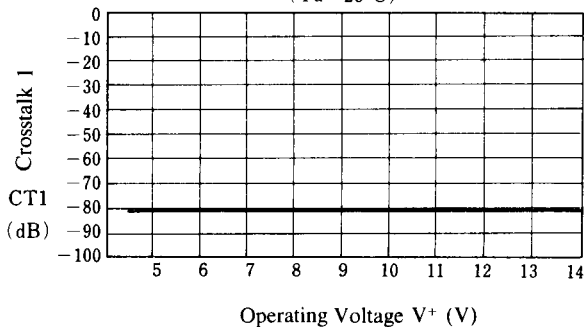

Crosstalk 2 vs. Operating Voltage

($T_a = 25^\circ\text{C}$)

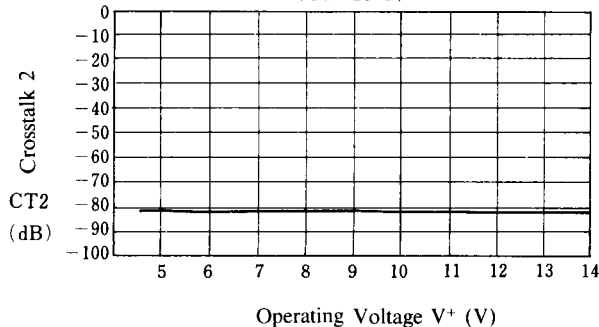

Crosstalk 3 vs. Operating Voltage

($T_a = 25^\circ\text{C}$)

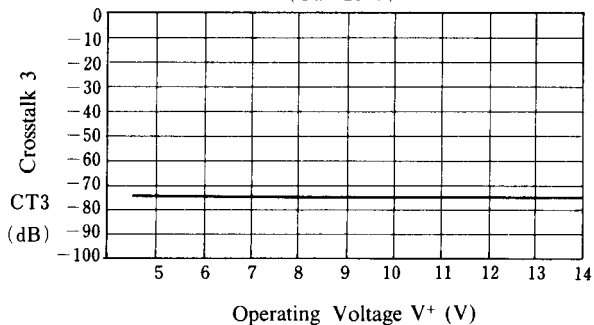

Crosstalk 4 vs. Operating Voltage

($T_a = 25^\circ\text{C}$)

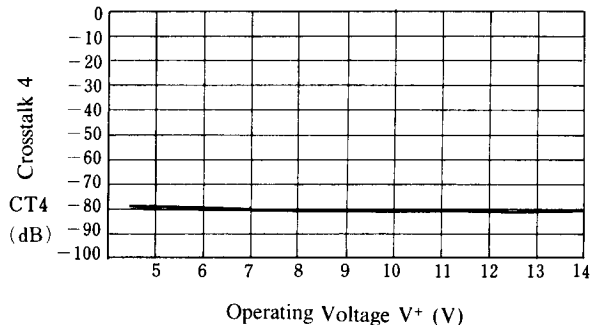

■ TYPICAL CHARACTERISTICS

Crosstalk 5 vs. Operating Voltage V^+ (V)
($T_a=25^\circ\text{C}$)

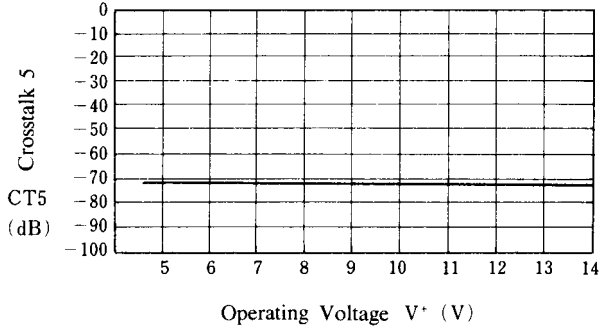

Crosstalk 6 vs. Operating Voltage V^+ (V)
($T_a=25^\circ\text{C}$)

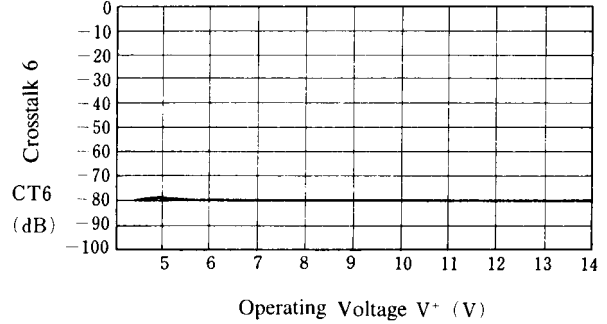

Switch Change Over 1 vs. Operating Voltage
($T_a=25^\circ\text{C}$)

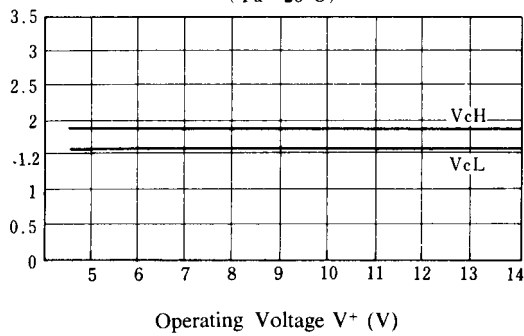

Differential Gain 1 vs. Frequency
($T_a=25^\circ\text{C}$)

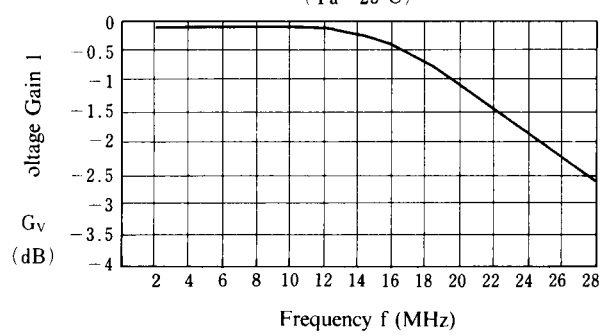

Differential Gain 1 vs. Load Resistor
($T_a=25^\circ\text{C}$)

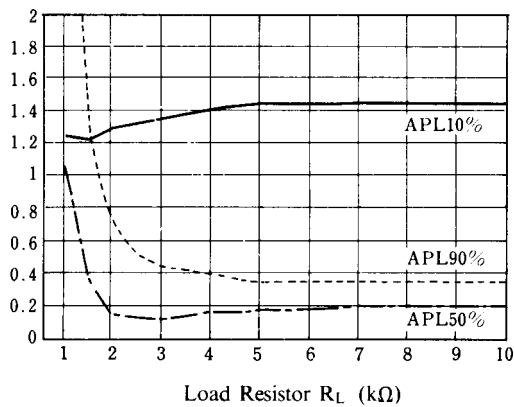

Differential Gain 3 vs. Load Resistor
($T_a=25^\circ\text{C}$)

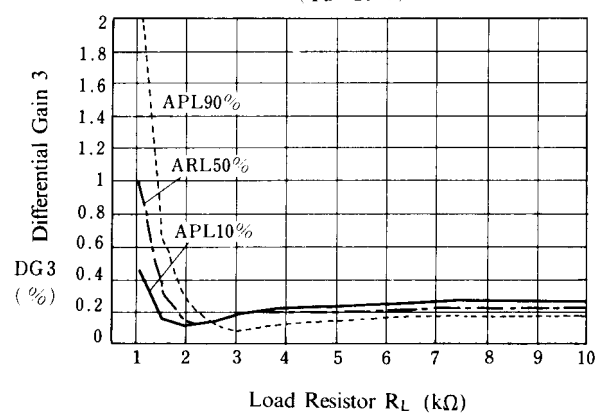

■ TYPICAL CHARACTERISTICS

Differential Phase 1 vs. Load Resistor

($T_a = 25^\circ\text{C}$)

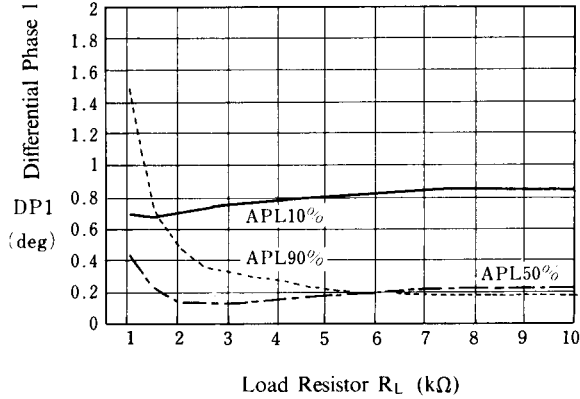

Differential Phase 3 vs. Load Resistor

($T_a = 25^\circ\text{C}$)

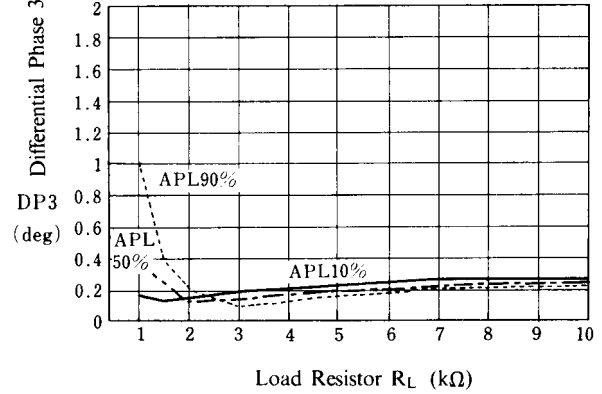

Differential Gain 1 vs. APL

($T_a = 25^\circ\text{C}$)

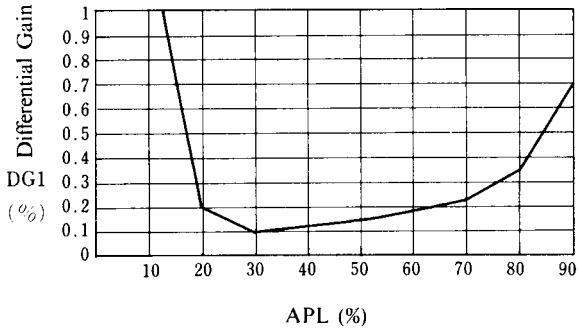

Differential Gain 3 vs. APL

($T_a = 25^\circ\text{C}$)

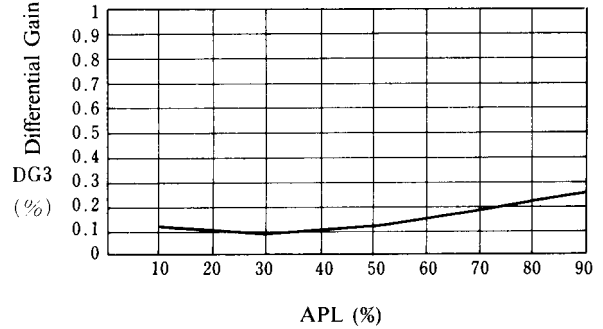

Differential Phase 1 vs. APL

($T_a = 25^\circ\text{C}$)

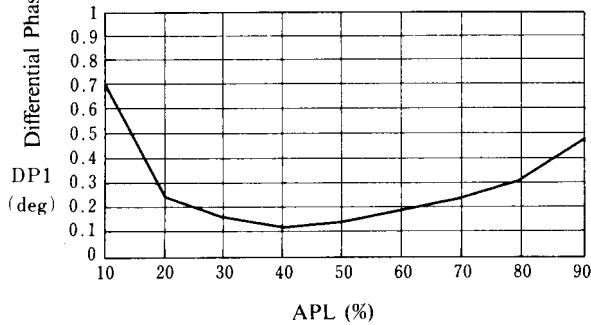

Differential Phase 3 vs. APL

($T_a = 25^\circ\text{C}$)

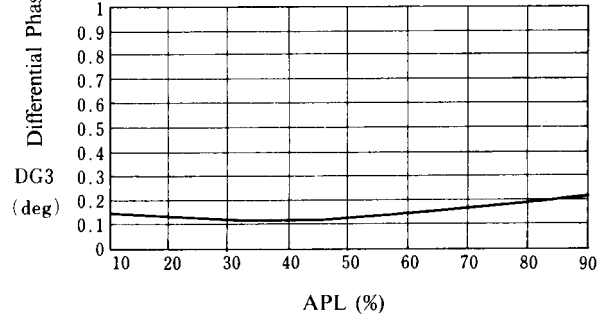

■ TYPICAL CHARACTERISTICS

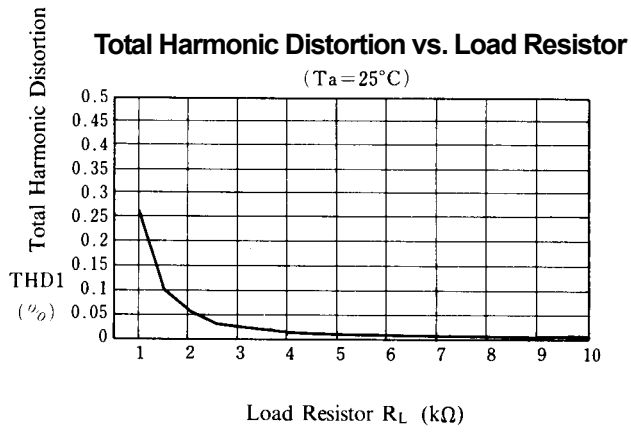

NJM2285

■ APPLICATION

This IC requires $1M\Omega$ resistance between INPUT and GND pin for clamp type input since the minute current causes an unstable pin voltage.

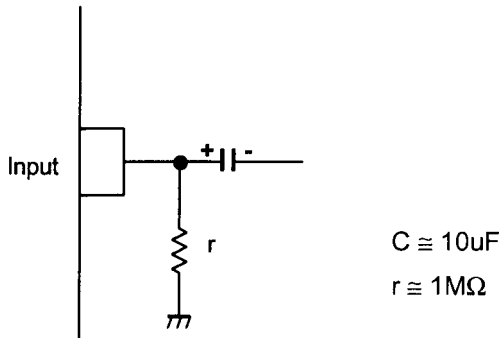

This IC requires $0.1\mu\text{F}$ capacitor between INPUT and GND, $1M\Omega$ resistance between INPUT and GND for clamp type input at mute mode.

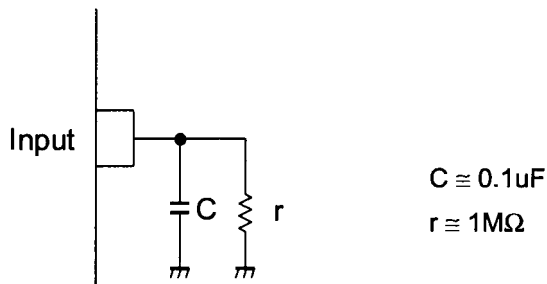

This IC requires $0.1\mu\text{F}$ capacitor between INPUT and GND for bias type input at mute mode.

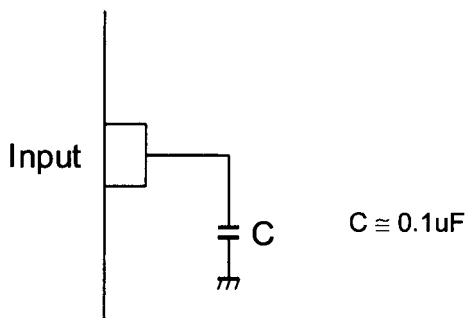

[CAUTION]
The specifications on this databook are only given for information, without any guarantee as regards either mistakes or omissions. The application circuits in this databook are described only to show representative usages of the product and not intended for the guarantee or permission of any right including the industrial rights.