

**Boost chopper & Phase Leg
Super Junction MOSFET
Power Module**

Boost chopper: $V_{DSS} = 600V$
 $R_{DSon} = 45m\Omega \text{ max @ } T_j = 25^\circ C$
 $I_D = 49A \text{ @ } T_c = 25^\circ C$

Phase leg: $V_{DSS} = 600V$
 $R_{DSon} = 83m\Omega \text{ max @ } T_j = 25^\circ C$
 $I_D = 36A \text{ @ } T_c = 25^\circ C$

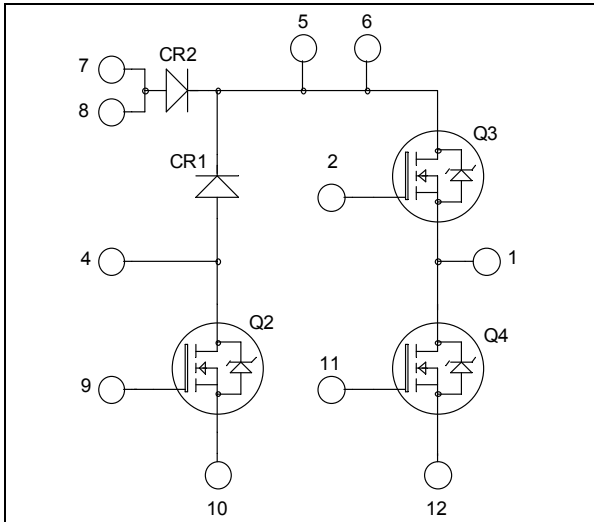

Application

- Welding converters
- Switched Mode Power Supplies
- Uninterruptible Power Supplies
- Solar converter

Features

- **CoolMOS™**
 - Ultra low R_{DSon}
 - Low Miller capacitance
 - Ultra low gate charge
 - Avalanche energy rated
 - Very rugged

- **By pass FRED diode (CR2)**

Benefits

- Very low stray inductance
- High level of integration
- Outstanding performance at high frequency operation
- Direct mounting to heatsink (isolated package)
- Low junction to case thermal resistance
- Solderable terminals both for power and signal for easy PCB mounting
- Low profile
- RoHS Compliant

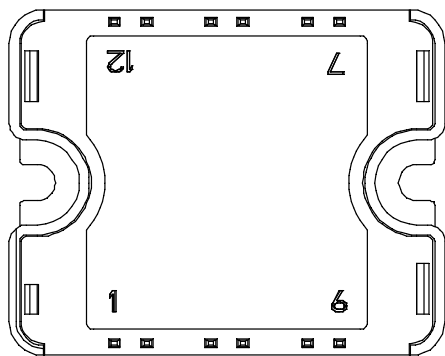

Pins 7/8 ; 5/6 must be shorted together

All ratings @ $T_j = 25^\circ C$ unless otherwise specified

CAUTION: These Devices are sensitive to Electrostatic Discharge. Proper Handling Procedures Should Be Followed. See application note APT0502 on www.microsemi.com

1. Phase leg (Q3 & Q4)
Absolute maximum ratings

Symbol	Parameter	Max ratings	Unit
V _{DSS}	Drain - Source Breakdown Voltage	600	V
I _D	Continuous Drain Current	T _c = 25°C	36
		T _c = 80°C	27
I _{DM}	Pulsed Drain current	115	A
V _{GS}	Gate - Source Voltage	±20	V
R _{DS(on)}	Drain - Source ON Resistance	83	mΩ
P _D	Maximum Power Dissipation	T _c = 25°C	250
I _{AR}	Avalanche current (repetitive and non repetitive)	20	A
E _{AR}	Repetitive Avalanche Energy	1	mJ
E _{AS}	Single Pulse Avalanche Energy	1800	

Electrical Characteristics

Symbol	Characteristic	Test Conditions	Min	Typ	Max	Unit
I _{DSS}	Zero Gate Voltage Drain Current	V _{GS} = 0V, V _{DS} = 600V T _j = 25°C			100	μA
		V _{GS} = 0V, V _{DS} = 600V T _j = 125°C			5000	
R _{DS(on)}	Drain - Source on Resistance	V _{GS} = 10V, I _D = 24.5A			83	mΩ
V _{GS(th)}	Gate Threshold Voltage	V _{GS} = V _{DS} , I _D = 3mA	3	4	5	V
I _{GSS}	Gate - Source Leakage Current	V _{GS} = ±20 V, V _{DS} = 0V			100	nA

Dynamic Characteristics

Symbol	Characteristic	Test Conditions	Min	Typ	Max	Unit
C _{iss}	Input Capacitance	V _{GS} = 0V ; V _{DS} = 25V f = 1MHz		7.2		nF
C _{rss}	Reverse Transfer Capacitance			0.041		
Q _g	Total gate Charge	V _{GS} = 10V V _{Bus} = 300V I _D = 36A		250		nC
Q _{gs}	Gate - Source Charge			43		
Q _{gd}	Gate - Drain Charge			135		
T _{d(on)}	Turn-on Delay Time	Inductive Switching (125°C) V _{GS} = 10V V _{Bus} = 400V I _D = 36A R _G = 5Ω		21		ns
T _r	Rise Time			30		
T _{d(off)}	Turn-off Delay Time			240		
T _f	Fall Time			52		
R _{thJC}	Junction to Case Thermal resistance				0.5	°C/W

Source - Drain diode ratings and characteristics

Symbol	Characteristic	Test Conditions	Min	Typ	Max	Unit
I _S	Continuous Source current (Body diode)	T _c = 25°C			36	A
		T _c = 80°C			27	
V _{SD}	Diode Forward Voltage	V _{GS} = 0V, I _S = - 36A			1.2	V
dv/dt	Peak Diode Recovery ①				40	V/ns
t _{rr}	Reverse Recovery Time	I _S = - 36A V _R = 350V di _S /dt = 100A/μs	T _j = 25°C		210	ns
			T _j = 125°C		350	
Q _{rr}	Reverse Recovery Charge	I _S = - 36A V _R = 350V di _S /dt = 100A/μs	T _j = 25°C		2	μC
			T _j = 125°C		5.4	

① dv/dt numbers reflect the limitations of the circuit rather than the device itself. I_S ≤ - 36A di_S/dt ≤ 100A/μs V_R ≤ V_{DSS} T_j ≤ 150°C

2. Boost chopper (CR1 & Q2)

Absolute maximum ratings

Symbol	Parameter	Max ratings	Unit
V _{DSS}	Drain - Source Breakdown Voltage	600	V
I _D	Continuous Drain Current	T _c = 25°C	49
		T _c = 80°C	38
I _{DM}	Pulsed Drain current	130	A
V _{GS}	Gate - Source Voltage	±20	V
R _{DS(on)}	Drain - Source ON Resistance	45	mΩ
P _D	Maximum Power Dissipation	T _c = 25°C	250
I _{AR}	Avalanche current (repetitive and non repetitive)	15	A
E _{AR}	Repetitive Avalanche Energy	3	mJ
E _{AS}	Single Pulse Avalanche Energy	1900	

Electrical Characteristics

Symbol	Characteristic	Test Conditions	Min	Typ	Max	Unit
I _{DSS}	Zero Gate Voltage Drain Current	V _{GS} = 0V, V _{DS} = 600V T _j = 25°C			250	μA
		V _{GS} = 0V, V _{DS} = 600V T _j = 125°C			500	
R _{DS(on)}	Drain – Source on Resistance	V _{GS} = 10V, I _D = 24.5A		40	45	mΩ
V _{GS(th)}	Gate Threshold Voltage	V _{GS} = V _{DS} , I _D = 3mA	2.1	3	3.9	V
I _{GSS}	Gate – Source Leakage Current	V _{GS} = ±20 V, V _{DS} = 0V			100	nA

Dynamic Characteristics

Symbol	Characteristic	Test Conditions	Min	Typ	Max	Unit
C _{iss}	Input Capacitance	V _{GS} = 0V ; V _{DS} = 25V f = 1MHz		7.2		nF
C _{oss}	Output Capacitance			8.5		
Q _g	Total gate Charge	V _{GS} = 10V V _{Bus} = 300V I _D = 49A		150		nC
Q _{gs}	Gate – Source Charge			34		
Q _{gd}	Gate – Drain Charge			51		
T _{d(on)}	Turn-on Delay Time	Inductive Switching (125°C) V _{GS} = 10V V _{Bus} = 400V I _D = 49A R _G = 5Ω		21		ns
T _r	Rise Time			30		
T _{d(off)}	Turn-off Delay Time			100		
T _f	Fall Time			45		
E _{on}	Turn-on Switching Energy	Inductive switching @ 25°C V _{GS} = 10V ; V _{Bus} = 400V I _D = 49A ; R _G = 5Ω		675		μJ
E _{off}	Turn-off Switching Energy			520		
E _{on}	Turn-on Switching Energy	Inductive switching @ 125°C V _{GS} = 10V ; V _{Bus} = 400V I _D = 49A ; R _G = 5Ω		1100		μJ
E _{off}	Turn-off Switching Energy			635		
R _{thJC}	Junction to Case Thermal resistance				0.5	°C/W

Diode ratings and characteristics (CR1)

<i>Symbol</i>	<i>Characteristic</i>	<i>Test Conditions</i>		<i>Min</i>	<i>Typ</i>	<i>Max</i>	<i>Unit</i>
V _{RRM}	Maximum Peak Repetitive Reverse Voltage			600			V
I _{RM}	Maximum Reverse Leakage Current	V _R =600V	T _j = 25°C			25	μA
			T _j = 125°C			500	
I _F	DC Forward Current	T _c = 80°C			60		A
V _F	Diode Forward Voltage	I _F = 60A			1.7	2.3	V
		I _F = 120A			2		
		I _F = 60A	T _j = 125°C		1.4		
t _{rr}	Reverse Recovery Time	I _F = 600A V _R = 400V di/dt = 200A/μs	T _j = 25°C		70		ns
			T _j = 125°C		140		
Q _{rr}	Reverse Recovery Charge	I _F = 600A V _R = 400V di/dt = 200A/μs	T _j = 25°C		100		nC
			T _j = 125°C		690		
R _{thJC}	Junction to Case Thermal Resistance					0.85	°C/W

3. By pass FRED diode (CR2)
Diode ratings and characteristics

<i>Symbol</i>	<i>Characteristic</i>	<i>Test Conditions</i>		<i>Min</i>	<i>Typ</i>	<i>Max</i>	<i>Unit</i>
V _{RRM}	Maximum Peak Repetitive Reverse Voltage			600			V
I _{RM}	Maximum Reverse Leakage Current	V _R =600V	T _j = 25°C			100	μA
			T _j = 150°C			350	
I _F	DC Forward Current	T _c = 80°C			30		A
V _F	Diode Forward Voltage	I _F = 30A V _{GE} = 0V	T _j = 25°C		1.6	2	V
			T _j = 150°C		1.5		
t _{rr}	Reverse Recovery Time	I _F = 30A V _R = 300V di/dt = 1800A/μs	T _j = 25°C		100		ns
			T _j = 150°C		150		
Q _{rr}	Reverse Recovery Charge	I _F = 30A V _R = 300V di/dt = 1800A/μs	T _j = 25°C		1.5		μC
			T _j = 150°C		3.1		
E _{rr}	Reverse Recovery Energy	I _F = 30A V _R = 300V di/dt = 1800A/μs	T _j = 25°C		0.34		mJ
			T _j = 150°C		0.75		
R _{thJC}	Junction to Case Thermal Resistance					2.45	°C/W

4. Thermal & Package characteristics

<i>Symbol</i>	<i>Characteristic</i>			<i>Min</i>	<i>Typ</i>	<i>Max</i>	<i>Unit</i>
V _{ISOL}	RMS Isolation Voltage, any terminal to case t=1 min, 50/60Hz			4000			V
T _J	Operating junction temperature range			-40		150*	°C
T _{STG}	Storage Temperature Range			-40		125	
T _C	Operating Case Temperature			-40		100	
Torque	Mounting torque	To heatsink	M4	2		3	N.m
Wt	Package Weight					80	g

* T_{jmax} = 175°C for by pass and SiC diode

SP1 Package outline (dimensions in mm)

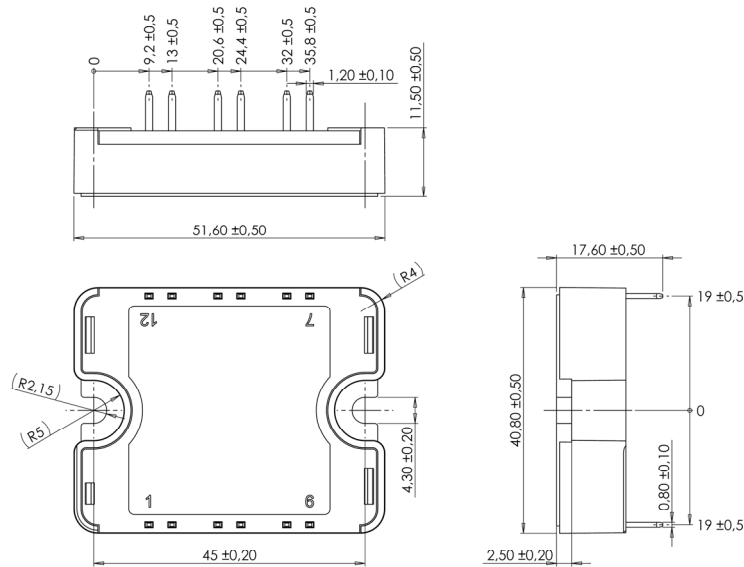

See application note 1904 - Mounting Instructions for SP1 Power Modules on www.microsemi.com

5. Typical CoolMOS Performance Curve (Boost chopper)

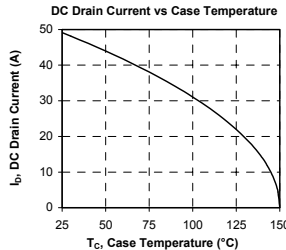
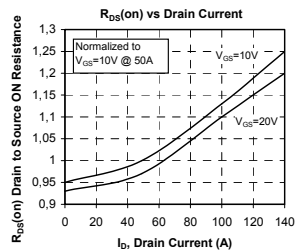
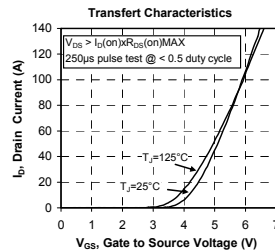
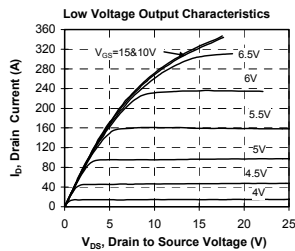
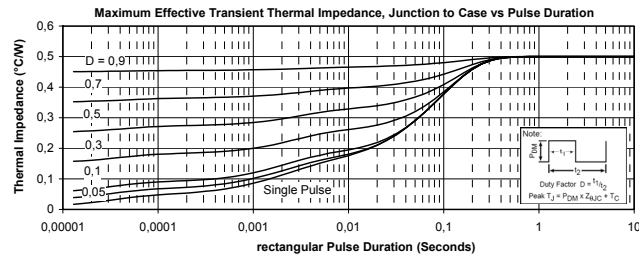

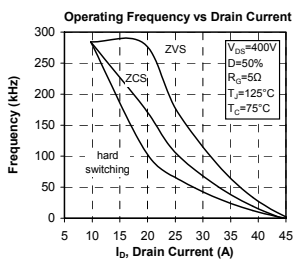
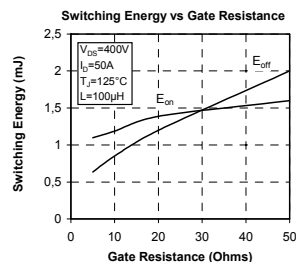
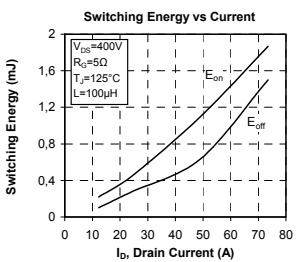
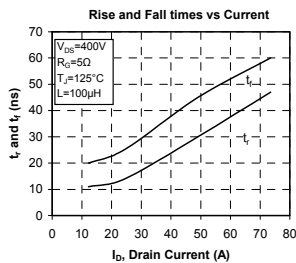
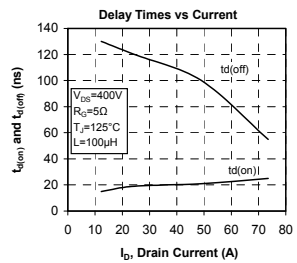
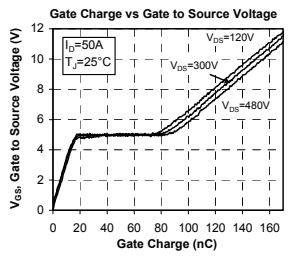
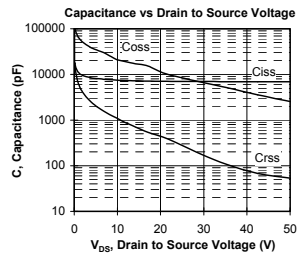
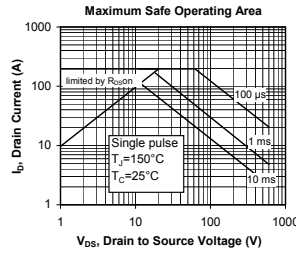
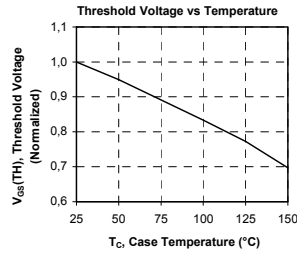
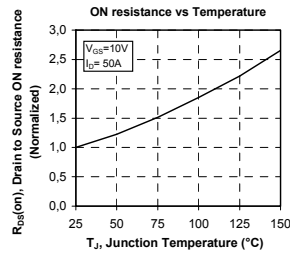
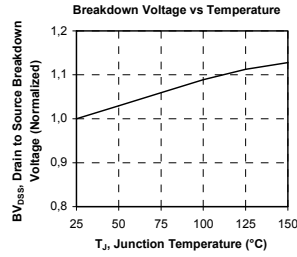

6. Typical Performance Curve (CR1)

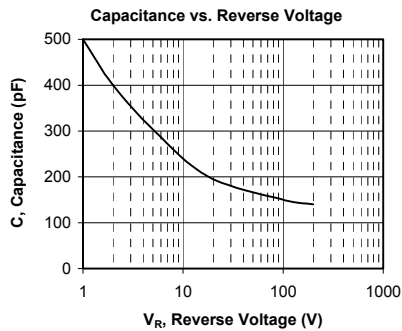
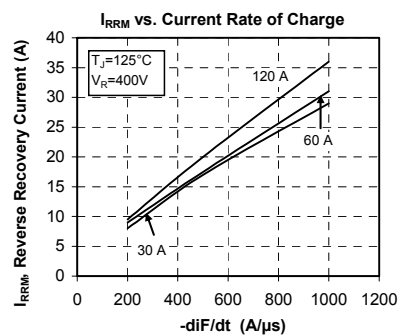
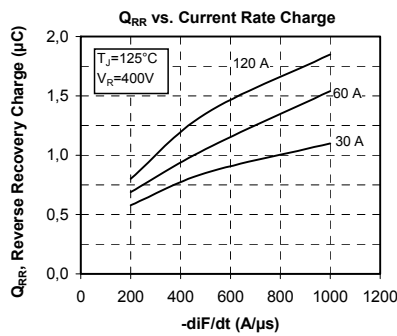
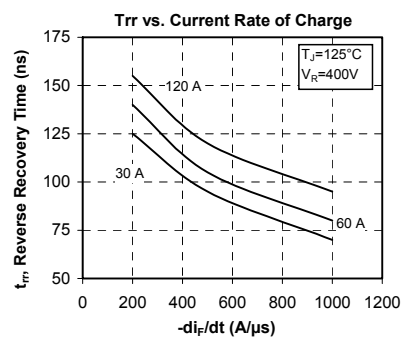
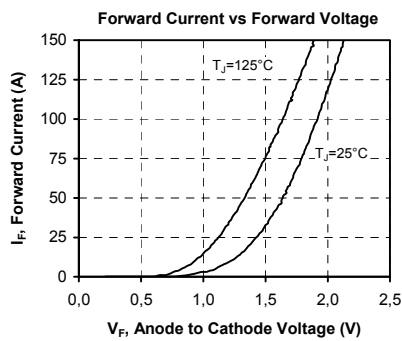
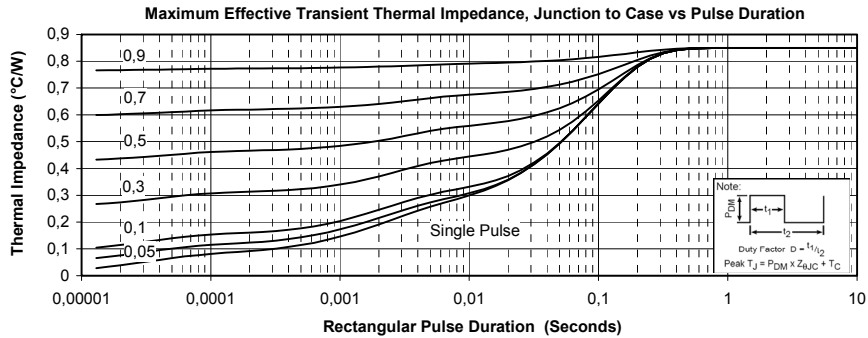

7. Typical CoolMOS Performance Curve (Phase leg)

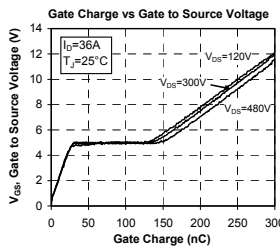
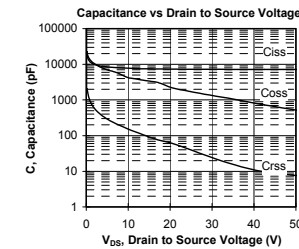
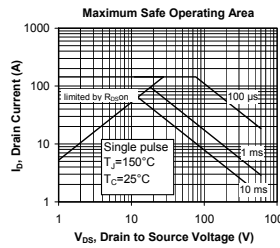
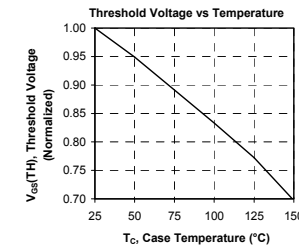
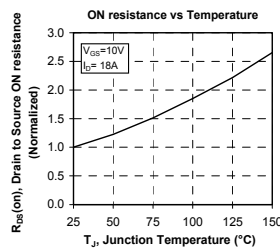
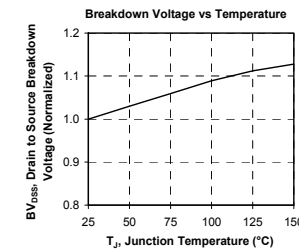
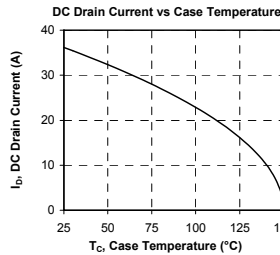
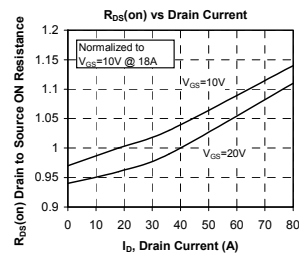
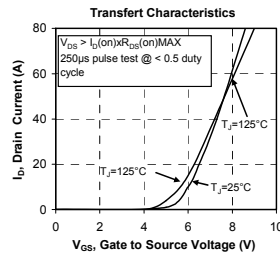
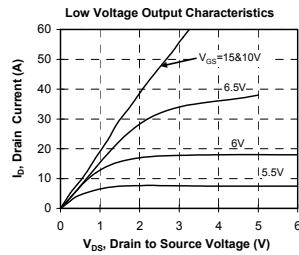
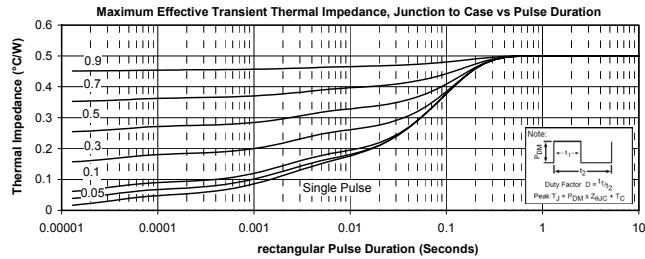

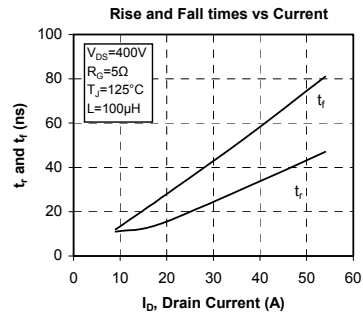
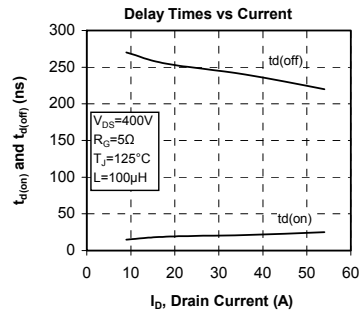

8. Typical By pass Performance Curve (CR2)

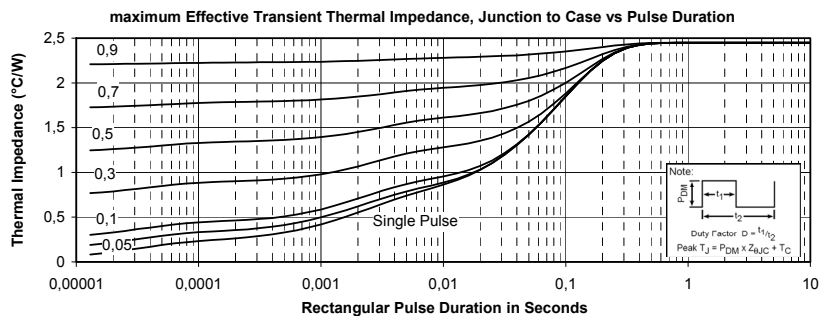
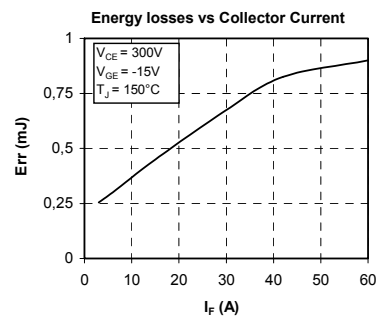
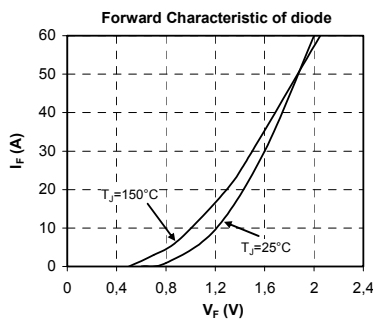

“COOLMOST™ comprise a new family of transistors developed by Infineon Technologies AG. “COOLMOS” is a trademark of Infineon Technologies AG”.

DISCLAIMER

The information contained in the document (unless it is publicly available on the Web without access restrictions) is PROPRIETARY AND CONFIDENTIAL information of Microsemi and cannot be copied, published, uploaded, posted, transmitted, distributed or disclosed or used without the express duly signed written consent of Microsemi. If the recipient of this document has entered into a disclosure agreement with Microsemi, then the terms of such Agreement will also apply. This document and the information contained herein may not be modified, by any person other than authorized personnel of Microsemi. No license under any patent, copyright, trade secret or other intellectual property right is granted to or conferred upon you by disclosure or delivery of the information, either expressly, by implication, inducement, estoppels or otherwise. Any license under such intellectual property rights must be approved by Microsemi in writing signed by an officer of Microsemi.

Microsemi reserves the right to change the configuration, functionality and performance of its products at anytime without any notice. This product has been subject to limited testing and should not be used in conjunction with life-support or other mission-critical equipment or applications. Microsemi assumes no liability whatsoever, and Microsemi disclaims any express or implied warranty, relating to sale and/or use of Microsemi products including liability or warranties relating to fitness for a particular purpose, merchantability, or infringement of any patent, copyright or other intellectual property right. Any performance specifications believed to be reliable but are not verified and customer or user must conduct and complete all performance and other testing of this product as well as any user or customers final application. User or customer shall not rely on any data and performance specifications or parameters provided by Microsemi. It is the customer's and user's responsibility to independently determine suitability of any Microsemi product and to test and verify the same. The information contained herein is provided "AS IS, WHERE IS" and with all faults, and the entire risk associated with such information is entirely with the User. Microsemi specifically disclaims any liability of any kind including for consequential, incidental and punitive damages as well as lost profit. The product is subject to other terms and conditions which can be located on the web at <http://www.microsemi.com/legal/tnc.asp>

Life Support Application

Seller's Products are not designed, intended, or authorized for use as components in systems intended for space, aviation, surgical implant into the body, in other applications intended to support or sustain life, or for any other application in which the failure of the Seller's Product could create a situation where personal injury, death or property damage or loss may occur (collectively "Life Support Applications").

Buyer agrees not to use Products in any Life Support Applications and to the extent it does it shall conduct extensive testing of the Product in such applications and further agrees to indemnify and hold Seller, and its officers, employees, subsidiaries, affiliates, agents, sales representatives and distributors harmless against all claims, costs, damages and expenses, and attorneys' fees and costs arising, directly or indirectly, out of any claims of personal injury, death, damage or otherwise associated with the use of the goods in Life Support Applications, even if such claim includes allegations that Seller was negligent regarding the design or manufacture of the goods.

Buyer must notify Seller in writing before using Seller's Products in Life Support Applications. Seller will study with Buyer alternative solutions to meet Buyer application specification based on Sellers sales conditions applicable for the new proposed specific part.