

## PIC16C77 Rev. A Silicon Errata Sheet

The PIC16C77 (Rev. A) parts you have received conform functionally to the Device Data Sheet (DS30390E), except for the anomalies described below.

All the problems listed here will be addressed in future revisions of the PIC16C77 silicon.

### 1. Module: 8-bit A/D Module

If the Analog Port is configured so that all analog pins are digital inputs (PCFG2:PCFG0 = 11x), then doing a conversion on any pin of the analog port will give a result of ADRES = 0xFF.

#### Work around

Configure the PCFG2:PCFG0 bits to a value that has any pin of the analog port configured as an analog input (such as PCFG2:PCFG0 = 100). Conversion on any pin of the analog port (analog or digital) will now convert as expected.

### 2. Module: CCP (Compare Mode)

The Compare mode may not operate as expected when configuring the compare match to drive the I/O pin low (CCPxM<3:0> = 1001).

When the CCP module is changed to compare output low (CCPxM<3:0> = 1001) from any other non-compare CCP mode, the I/O pin will immediately be driven low, regardless of the state of the I/O data latch. The pin will remain low when the compare match occurs (see Table 1).

However, when the CCP module is changed to compare output high (CCPxM<3:0> = 1000) from any other CCP mode, the I/O pin will immediately be driven low, regardless of the state of the I/O data latch. The pin will be driven high when the compare match occurs.

**TABLE 1: COMPARE OUTPUT LOW SWITCHING**

CCP Mode CCPxM<3:0> =	I/O pin State	Change CCP to CCPxM<3:0> =	
		1001	1000
0xxx	H	L	L
	L	L	L
1000	H	H	—
	L	L	—
1001	H	—	L
	L	—	L
101x	H	L	L
	L	L	L
11xx	H	L	L
	L	L	L

#### Work around

To have the I/O pin high until the compare match low occurs, force a compare match high to get the I/O pin into the high state, then reconfigure the compare match to force the I/O low when the compare condition occurs.

# PIC16C77

---

## 3. Module: SSP Module (I<sup>2</sup>C™ mode)

If the bus is active when the I<sup>2</sup>C mode is enabled, and the next 8 bits of data on the bus match the address of the device, then the SSP module will generate an Acknowledge pulse.

### **Work around**

Before enabling the I<sup>2</sup>C mode, ensure that the bus is not active.

## 4. Module: Timer0

The TMR0 register may increment when the WDT postscaler is switched to the Timer0 prescaler. If TMR0 = FFh, this will cause TMR0 to overflow (setting TOIF).

### **Work around**

Follow the following sequence:

- a) Read the 8-bit TMR0 register into the W register
- b) Clear the TMR0 register
- c) Assign WDT postscaler to Timer0
- d) Write W register to TMR0

## Clarifications/Corrections to the Data Sheet:

In the Device Data Sheet (DS30390E), the following clarifications and corrections should be noted.

### 1. Module: I/O Ports

The specification for the High Voltage Open Drain I/O (parameter D150, the RA4 pin) cannot be met without possible long term reliability issues on that I/O pin. If a high voltage drive is required, use an external transistor that can support the required voltage. The new value is shown in Table 2.

**TABLE 2: DC SPECIFICATION CHANGES FROM DATA SHEET**

Param No.	Sym.	Characteristic	New Specification			Data Sheet Specification			Units
			Min	Typ	Max	Min	Typ	Max	
D150	VOD	RA4 Open Drain High Voltage	—	—	10	—	—	14	V

### 2. Module: 8-Bit A/D

The minimum A/D reference voltage (parameter A20) has been improved. The new value is shown in Table 3.

**TABLE 3: DC SPECIFICATION CHANGES FROM DATA SHEET**

Param No.	Sym.	Characteristic	New Specification			Data Sheet Specification			Units
			Min	Typ	Max	Min	Typ	Max	
A20	VREF	Reference Voltage	2.5*	—	V <sub>DD</sub> + 0.3 V	3.0	—	V <sub>DD</sub> + 0.3 V	V

\* This parameter is characterized but not tested.

# PIC16C77

## 3. Module: SSP (SPI™ Mode Timing Specifications)

The SPI interface timings (parameters 71, 71A, 72, 72A, 73, and 73A) have been modified. The new values are shown in Table 4.

**TABLE 4: DC SPECIFICATION CHANGES FROM DATA SHEET**

Param No.	Sym.	Characteristic		New Specification			Data Sheet Specification			Units
				Min	Typ	Max	Min	Typ	Max	
71	Tsch	SCK input high time (Slave mode)	Continuous	1.25 T <sub>CY</sub> + 30 ns	—	—	T <sub>CY</sub> + 20 ns	—	—	ns
71A			Single Byte <sup>(1)</sup>	40	—	—	N.A.			ns
72	TscL	SCK input low time (Slave mode)	Continuous	1.25 T <sub>CY</sub> + 30 ns	—	—	T <sub>CY</sub> + 20 ns	—	—	ns
72A			Single Byte <sup>(1)</sup>	40	—	—	N.A.			ns
73A	Tb2B	Last clock edge of the Byte1 to 1st clock edge of the Byte2 <sup>(1)</sup>		1.5 T <sub>CY</sub> + 40 ns	—	—	N.A.			ns

\* This parameter is characterized but not tested.

**Note 1:** Specification 73A is only required if specifications 71A and 72A are used.

## 4. Module: Timer1

The operation of Timer1 needs some clarification when the timer registers are written when the TMR1ON bit is set.

The internal clock signal that is the input to the TMR1 prescaler affects the incrementing of Timer1 (TMR1H:TMR1L registers and the Timer1 prescaler). When the Timer1 registers are NOT written, the Timer1 will increment on the rising edge of the TMR1 increment clock.

When the TMR1H and/or TMR1L registers are written while this clock is high, TMR1 will increment on the next rising edge of this clock.

When the TMR1H and/or TMR1L registers are written while this clock is low, TMR1 will not increment on the next rising edge of this clock, but must first have a falling clock and the rising clock, for TMR1 to increment.

Figure 1 shows the two cases of writes to the TMR1H and/or TMR1L registers. Due to the V<sub>IH</sub> and V<sub>IL</sub> thresholds on the oscillator/clock pins, external Timer1 oscillator components, and external clock frequency, the Timer1 increment clock may not be of a 50% duty cycle.

The TMR1 increment clock is out of phase of the T1OSO/T1CKI pin by a small propagation delay.

**FIGURE 1: WRITES TO TIMER1 (EXTERNAL CLOCK/OSCILLATOR MODE)**

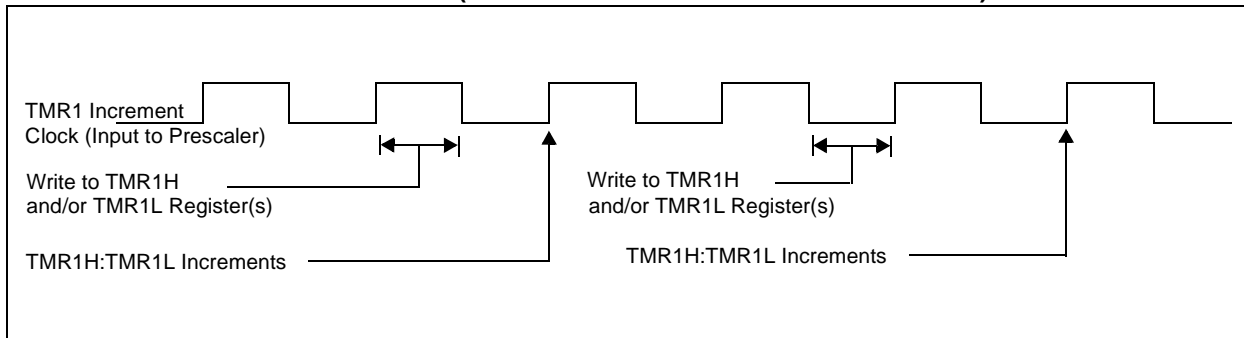

## 5. Module: RC Oscillator

The table for RC Oscillator Frequencies in the Device Characterization section of the Data Sheet is incorrect. The correct characterization information is shown in Table 5.

**TABLE 5: RC OSCILLATOR FREQUENCIES CHARACTERIZATION CHANGES FROM DATA SHEET**

CEXT	REXT	Correct Characterization Data		Current Data Sheet Values	
		Average	% Variation	Average	% Variation
22 pF	5.1 K	3.55 MHz	± 9.63%	4.12 MHz	± 1.4%
	10 K	1.99 MHz	± 10.53%	2.35 MHz	± 1.4%
	100 K	221.9 kHz	± 12.10%	268 kHz	± 1.1%
100 pF	3.3 K	1.77 MHz	± 10.67%	1.80 MHz	± 1.0%
	5.1 K	1.22 MHz	± 10.41%	1.27 MHz	± 1.0%
	10 K	669.4 kHz	± 10.92%	688 kHz	± 1.2%
	100 K	71.5 kHz	± 11.21%	77.2 kHz	± 1.0%
330 pF	3.3 K	625.1 kHz	± 10.68%	707 kHz	± 1.4%
	5.1 K	428.5 kHz	± 10.96%	501 kHz	± 1.2%
	10 K	231.9 kHz	± 11.32%	269 kHz	± 1.6%
	100 K	24.4 kHz	± 12.93%	28.3 kHz	± 1.1%

The percentage variation indicated here is part-to-part variation due to normal process distribution. The variation indicated is  $\pm 3$  standard deviation from the average value for  $V_{DD} = 5V$ .

## 6. Module: Brown-Out Reset (BOR)

The levels specified for the BOR module thresholds (parameter D005) have changed. The new values are shown in Table 6.

**TABLE 6: MINIMUM AND MAXIMUM BOR RESET VOLTAGES**

Param No.	Sym.	Characteristic	New Specification			Data Sheet Specification			Units
			Min	Typ	Max	Min	Typ	Max	
D005	VBOR	Brown-out Reset Voltage	3.65	—	4.35	3.70	—	4.30	V

# PIC16C77

---

NOTES:

---

“All rights reserved. Copyright © 2001, Microchip Technology Incorporated, USA. Information contained in this publication regarding device applications and the like is intended through suggestion only and may be superseded by updates. No representation or warranty is given and no liability is assumed by Microchip Technology Incorporated with respect to the accuracy or use of such information, or infringement of patents or other intellectual property rights arising from such use or otherwise. Use of Microchip’s products as critical components in life support systems is not authorized except with express written approval by Microchip. No licenses are conveyed, implicitly or otherwise, under any intellectual property rights. The Microchip logo and name are registered trademarks of Microchip Technology Inc. in the U.S.A. and other countries. All rights reserved. All other trademarks mentioned herein are the property of their respective companies. No licenses are conveyed, implicitly or otherwise, under any intellectual property rights.”

#### Trademarks

The Microchip name, logo, PIC, PICmicro, PICMASTER, PICSTART, PRO MATE, KEELOQ, SEEVAL, MPLAB and The Embedded Control Solutions Company are registered trademarks of Microchip Technology Incorporated in the U.S.A. and other countries.

Total Endurance, ICSP, In-Circuit Serial Programming, Filter-Lab, MXDEV, microlD, FlexROM, fuzzyLAB, MPASM, MPLINK, MPLIB, PICDEM, ICEPIC, Migratable Memory, FanSense, ECONOMONITOR, SelectMode and microPort are trademarks of Microchip Technology Incorporated in the U.S.A.

Serialized Quick Term Programming (SQTP) is a service mark of Microchip Technology Incorporated in the U.S.A.

All other trademarks mentioned herein are property of their respective companies.

© 2001, Microchip Technology Incorporated, Printed in the U.S.A., All Rights Reserved.

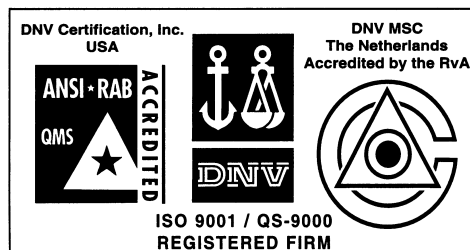

Microchip received QS-9000 quality system certification for its worldwide headquarters, design and wafer fabrication facilities in Chandler and Tempe, Arizona in July 1999. The Company's quality system processes and procedures are QS-9000 compliant for its PICmicro® 8-bit MCUs, KEELOQ® code hopping devices, Serial EEPROMs and microperipheral products. In addition, Microchip's quality system for the design and manufacture of development systems is ISO 9001 certified.



## WORLDWIDE SALES AND SERVICE

### AMERICAS

#### Corporate Office

2355 West Chandler Blvd.  
Chandler, AZ 85224-6199  
Tel: 480-792-7200 Fax: 480-792-7277  
Technical Support: 480-792-7627  
Web Address: <http://www.microchip.com>

#### Rocky Mountain

2355 West Chandler Blvd.  
Chandler, AZ 85224-6199  
Tel: 480-792-7966 Fax: 480-792-7456

#### Atlanta

500 Sugar Mill Road, Suite 200B  
Atlanta, GA 30350  
Tel: 770-640-0034 Fax: 770-640-0307

#### Austin

Analog Product Sales  
8303 MoPac Expressway North  
Suite A-201  
Austin, TX 78759  
Tel: 512-345-2030 Fax: 512-345-6085

#### Boston

2 Lan Drive, Suite 120  
Westford, MA 01886  
Tel: 978-692-3848 Fax: 978-692-3821

#### Boston

Analog Product Sales  
Unit A-8-1 Millbrook Tarry Condominium  
97 Lowell Road  
Concord, MA 01742  
Tel: 978-371-6400 Fax: 978-371-0050

#### Chicago

333 Pierce Road, Suite 180  
Itasca, IL 60143  
Tel: 630-285-0071 Fax: 630-285-0075

#### Dallas

4570 Westgrove Drive, Suite 160  
Addison, TX 75001  
Tel: 972-818-7423 Fax: 972-818-2924

#### Dayton

Two Prestige Place, Suite 130  
Miamisburg, OH 45342  
Tel: 937-291-1654 Fax: 937-291-9175

#### Detroit

Tri-Atria Office Building  
3225 Northwestern Highway, Suite 190  
Farmington Hills, MI 48334  
Tel: 248-538-2250 Fax: 248-538-2260

#### Los Angeles

18201 Von Karman, Suite 1090  
Irvine, CA 92612  
Tel: 949-263-1888 Fax: 949-263-1338

#### Mountain View

Analog Product Sales  
1300 Terra Bella Avenue  
Mountain View, CA 94043-1836  
Tel: 650-968-9241 Fax: 650-967-1590

#### New York

150 Motor Parkway, Suite 202  
Hauppauge, NY 11788  
Tel: 631-273-5305 Fax: 631-273-5335

#### San Jose

Microchip Technology Inc.  
2107 North First Street, Suite 590  
San Jose, CA 95131  
Tel: 408-436-7950 Fax: 408-436-7955

#### Toronto

6285 Northam Drive, Suite 108  
Mississauga, Ontario L4V 1X5, Canada  
Tel: 905-673-0699 Fax: 905-673-6509

### ASIA/PACIFIC

#### Australia

Microchip Technology Australia Pty Ltd  
Suite 22, 41 Rawson Street  
Epping 2121, NSW  
Australia  
Tel: 61-2-9868-6733 Fax: 61-2-9868-6755

#### China - Beijing

Microchip Technology Beijing Office  
Unit 915  
New China Hong Kong Manhattan Bldg.  
No. 6 Chaoyangmen Beidajie  
Beijing, 100027, No. China  
Tel: 86-10-85282100 Fax: 86-10-85282104

#### China - Shanghai

Microchip Technology Shanghai Office  
Room 701, Bldg. B  
Far East International Plaza  
No. 317 Xian Xia Road  
Shanghai, 200051  
Tel: 86-21-6275-5700 Fax: 86-21-6275-5060

#### Hong Kong

Microchip Asia Pacific  
RM 2101, Tower 2, Metroplaza  
223 Hing Fong Road  
Kwai Fong, N.T., Hong Kong  
Tel: 852-2401-1200 Fax: 852-2401-3431

#### India

Microchip Technology Inc.  
India Liaison Office  
Divyasree Chambers  
1 Floor, Wing A (A3/A4)  
No. 11, O'Shaughnessey Road  
Bangalore, 560 025, India  
Tel: 91-80-2290061 Fax: 91-80-2290062

#### Japan

Microchip Technology Intl. Inc.  
Benex S-1 6F  
3-18-20, Shinyokohama  
Kohoku-Ku, Yokohama-shi  
Kanagawa, 222-0033, Japan  
Tel: 81-45-471-6166 Fax: 81-45-471-6122

### ASIA/PACIFIC (continued)

#### Korea

Microchip Technology Korea  
168-1, Youngbo Bldg. 3 Floor  
Samsung-Dong, Kangnam-Ku  
Seoul, Korea  
Tel: 82-2-554-7200 Fax: 82-2-558-5934

#### Singapore

Microchip Technology Singapore Pte Ltd.  
200 Middle Road  
#07-02 Prime Centre  
Singapore, 188980  
Tel: 65-334-8870 Fax: 65-334-8850

#### Taiwan

Microchip Technology Taiwan  
11F-3, No. 207  
Tung Hua North Road  
Taipei, 105, Taiwan  
Tel: 886-2-2717-7175 Fax: 886-2-2545-0139

### EUROPE

#### Denmark

Microchip Technology Denmark ApS  
Regus Business Centre  
Lautrup høj 1-3  
Ballerup DK-2750 Denmark  
Tel: 45 4420 9895 Fax: 45 4420 9910

#### France

Arizona Microchip Technology SARL  
Parc d'Activite du Moulin de Massy  
43 Rue du Saule Trapu  
Batiment A - 1er Etage  
91300 Massy, France  
Tel: 33-1-69-53-63-20 Fax: 33-1-69-30-90-79

#### Germany

Arizona Microchip Technology GmbH  
Gustav-Heinemann Ring 125  
D-81739 Munich, Germany  
Tel: 49-89-627-144 0 Fax: 49-89-627-144-44

#### Germany

Analog Product Sales  
Lochhamer Strasse 13  
D-82152 Martinsried, Germany  
Tel: 49-89-895650-0 Fax: 49-89-895650-22

#### Italy

Arizona Microchip Technology SRL  
Centro Direzionale Colleoni  
Palazzo Taurus 1 V. Le Colleoni 1  
20041 Agrate Brianza  
Milan, Italy  
Tel: 39-039-65791-1 Fax: 39-039-6899883

#### United Kingdom

Arizona Microchip Technology Ltd.  
505 Eskdale Road  
Winnersh Triangle  
Wokingham  
Berkshire, England RG41 5TU  
Tel: 44 118 921 5869 Fax: 44-118 921-5820

01/30/01

All rights reserved. © 2001 Microchip Technology Incorporated. Printed in the USA. 2/01  Printed on recycled paper.

Information contained in this publication regarding device applications and the like is intended through suggestion only and may be superseded by updates. It is your responsibility to ensure that your application meets with your specifications. No representation or warranty is given and no liability is assumed by Microchip Technology Incorporated with respect to the accuracy or use of such information, or infringement of patents or other intellectual property rights arising from such use or otherwise. Use of Microchip's products as critical components in life support systems is not authorized except with express written approval by Microchip. No licenses are conveyed, implicitly or otherwise, except as maybe explicitly expressed herein, under any intellectual property rights. The Microchip logo and name are registered trademarks of Microchip Technology Inc. in the U.S.A. and other countries. All rights reserved. All other trademarks mentioned herein are the property of their respective companies.