

# 42   0.9°

# 17PY-Z

0.9°

## ■ 外觀図 Outline

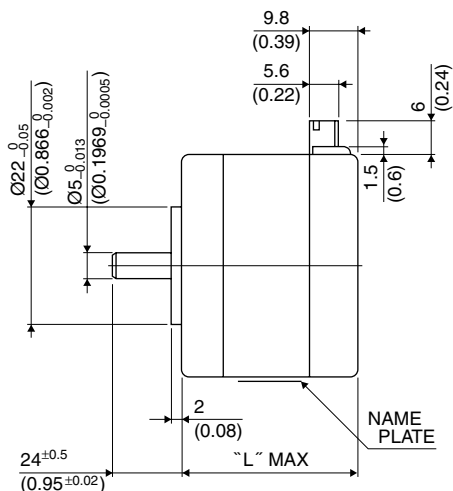
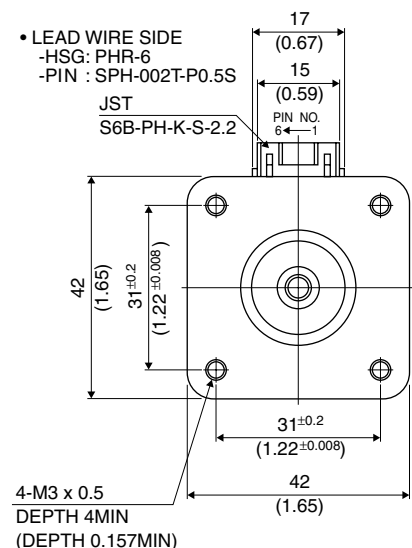

Hybrid

UNIT:  $\frac{\text{mm}}{\text{(inch)}}$

結線表 PIN NO. vs. PHASE

相 (PHASE)	A	A COM	$\bar{A}$	B	B COM	$\bar{B}$
ピン番号 (PIN NO.)	4	5	6	3	2	1

	"L"
17PY-Z7**	26 (1.02)
17PY-Z2**	30 (1.18)
17PY-Z0**	34 (1.34)
17PY-Z3**	38 (1.50)
17PY-Z1**	42 (1.65)
17PY-Z4**	48 (1.89)

## ■ 仕様 Specifications

型式	ステップ角	ドライブ方式	定格電流	巻線抵抗	ホールディングトルク	インダクタンス	ロータイナーシャ	ディテントトルク	質量
Model	Step Angle	Drive Sequence	Rated Current	Resistance	Holding Torque	Inductance	Rotor Inertia	Detent Torque	Mass
	(deg)		(A)	(Ohms)	(mNm)	(mH)	(g·cm <sup>2</sup> )	(mNm)	(g)
17PY-Z049U	0.9	UNI-POLAR	1	3.1	220	4.4	37	10.8	200
17PY-Z064U	0.9	UNI-POLAR	0.6	8.3	220	11.1	37	10.8	200
17PY-Z142U	0.9	UNI-POLAR	1.4	2.3	300	4.7	62	11.8	300
17PY-Z149U	0.9	UNI-POLAR	1	4.3	300	8.7	62	11.8	300
17PY-Z249U	0.9	UNI-POLAR	0.8	2.7	120	3.8	24	4.4	180
17PY-Z264U	0.9	UNI-POLAR	0.6	6.9	120	2.5	24	4.4	180
17PY-Z342U	0.9	UNI-POLAR	1.4	2.0	280	3.5	50	12.0	250
17PY-Z349U	0.9	UNI-POLAR	1	3.6	280	6.5	50	12.0	250
17PY-Z442U	0.9	UNI-POLAR	1.4	2.8	450	4.5	75	18.7	350
17PY-Z449U	0.9	UNI-POLAR	1	4.9	450	8.4	75	18.7	350
17PY-Z749U	0.9	UNI-POLAR	0.9	2.2	48	1.9	11	3.0	150
17PY-Z764U	0.9	UNI-POLAR	0.6	5.6	48	1.2	11	3.0	150
17PY-Z049B	0.9	BI-POLAR	0.7	6.2	270	17.5	37	10.8	200
17PY-Z142B	0.9	BI-POLAR	1	4.6	390	18.6	62	11.8	300
17PY-Z249B	0.9	BI-POLAR	0.6	5.4	160	15.2	24	4.4	180
17PY-Z342B	0.9	BI-POLAR	0.9	4.0	340	13.8	50	12.0	250
17PY-Z442B	0.9	BI-POLAR	0.9	5.6	540	18.0	75	18.7	350
17PY-Z749B	0.9	BI-POLAR	0.6	4.4	63	7.8	11	3.0	150

# ■ トルク・スピード特性 Torque/Speed Characteristics

Model No: 17PY-Z049U,Z064U,Z049B  
 Driver: Chopper Dual  
 Supply Voltage: 24.0 (Volt)

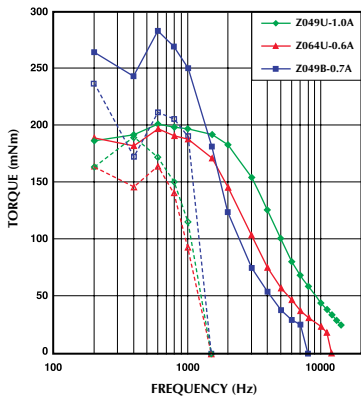

Model No: 17PY-Z142U,Z149U,Z142B  
 Driver: Chopper Dual  
 Supply Voltage: 24.0 (Volt)

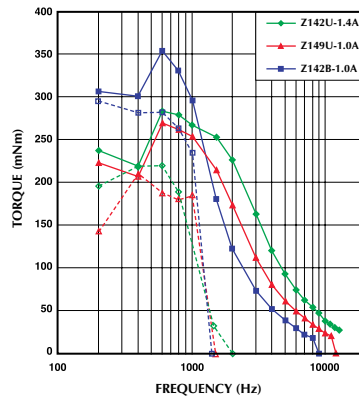

Model No: 17PY-Z249U,Z264U,Z249B  
 Driver: Chopper Dual  
 Supply Voltage: 24.0 (Volt)

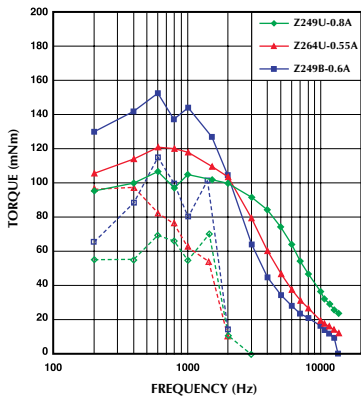

Model No: 17PY-Z342U,Z349U,Z342B  
 Driver: Chopper Dual  
 Supply Voltage: 24.0 (Volt)

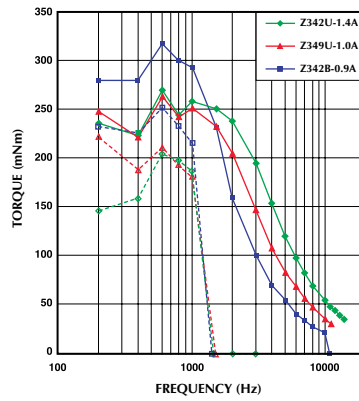

Model No: 17PY-Z442U,Z449U,Z442B  
 Driver: Chopper Dual  
 Supply Voltage: 24.0 (Volt)

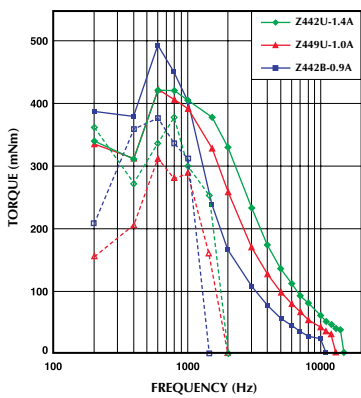

Model No: 17PY-Z749U,Z764U,Z749B  
 Driver: Chopper Dual  
 Supply Voltage: 24.0 (Volt)

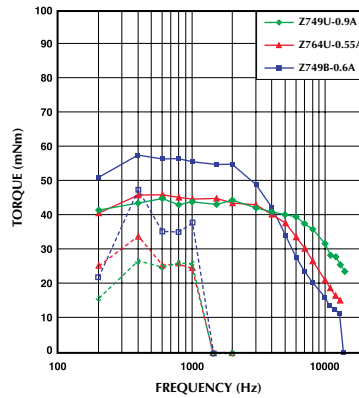

— : PULL OUT  
 - - - : PULL IN