

ASMT-Jx32

3W Mini Power LED Light Source

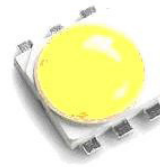

Data Sheet



Description

The 3W Mini Power LED Light Source is a high performance energy efficient device which can handle high thermal and high driving current. The metal slug is electrically isolated.

The White Mini Power LED is available in the range of color temperature from 2700K to 10000K.

The low profile package design and ultra small footprint is suitable for a wide variety of applications especially where space and height is a constraint.

The package is compatible with reflow soldering process. To facilitate easy pick & place assembly, the LEDs are packed in EIA-compliant tape and reel.

Features

- Available in Cool White, Neutral White and Warm White
- Small footprint and low profile
- Symmetrical outline
- Energy efficient
- Direct heat transfer from metal slug to mother board
- Compatible with reflow soldering process
- High current operation
- Long operation life
- Wide viewing angle
- Silicone encapsulation
- Non-ESD sensitive (threshold > 16kV)
- MSL 1 products

Applications

- Sign backlight
- Safety, exit and emergency sign lightings
- Specialty lighting such as task lighting and reading lights
- Retail display
- Commercial lighting
- Accent or marker lightings, strip or step lightings
- Portable lightings, bicycle head lamp, torch lights
- Decorative lighting
- Architectural lighting
- Pathway lighting
- Street lighting
- Pedestrian street lighting
- Tunnel lighting

CAUTION: Customer is advised to keep the LEDs in the MBB when not in use as prolonged exposure to environment might cause the silver plated leads to tarnish, which might cause difficulties in soldering.

Package Dimensions

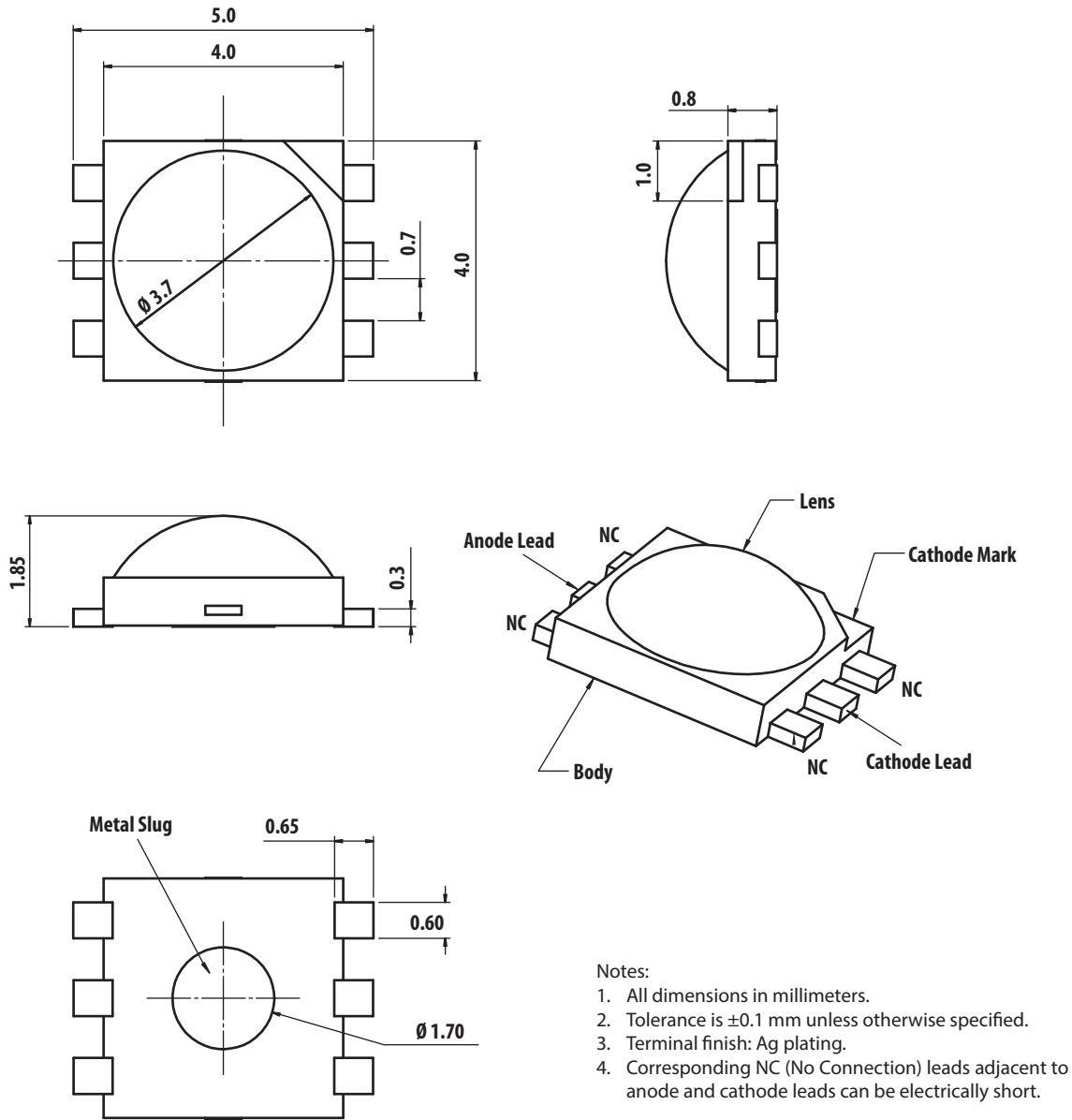
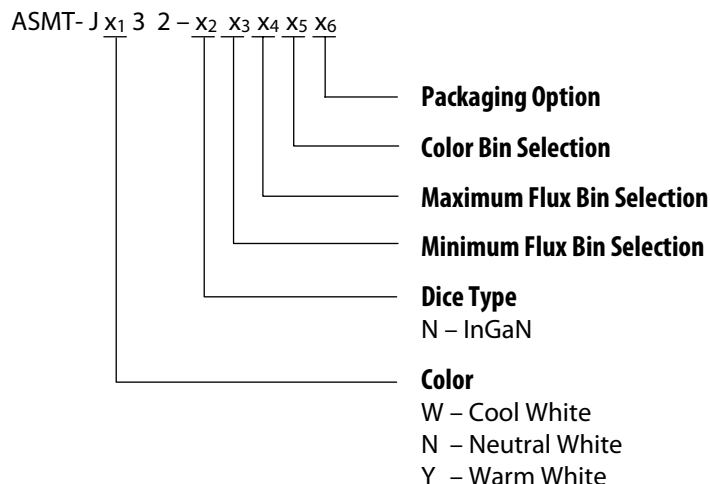

Figure 1. ASMT-Jx32 package outline drawing

Part Numbering System



Note:

1. Please refer to Page 8 for selection details.

Device Selection Guide (T_J = 25°C)

| Part Number | Color | Luminous Flux (lm), $\Phi_V^{[1,2]}$ | | | Test Current (mA) | Dice Technology | Electrically Isolated Metal Slug |
|-----------------|---------------|--------------------------------------|-------|-------|-------------------|-----------------|----------------------------------|
| | | Min. | Typ. | Max. | | | |
| ASMT-JW32-NWY01 | Cool White | 113.6 | 140.0 | 168.4 | 350 | InGaN | Yes |
| ASMT-JW32-NWYJ1 | | 113.6 | 140.0 | 168.4 | 350 | InGaN | Yes |
| ASMT-JN32-NWY01 | Neutral White | 113.6 | 140.0 | 168.4 | 350 | InGaN | Yes |
| ASMT-JN32-NWYH1 | | 113.6 | 140.0 | 168.4 | 350 | InGaN | Yes |
| ASMT-JY32-NWY01 | Warm White | 113.6 | 130.0 | 168.4 | 350 | InGaN | Yes |
| ASMT-JY32-NWYK1 | | 113.6 | 130.0 | 168.4 | 350 | InGaN | Yes |

Notes:

1. Φ_V is the total luminous flux output as measured with an integrating sphere at 25ms mono pulse condition.
2. Flux tolerance is $\pm 10\%$

Absolute Maximum Ratings

| Parameter | ASMT-Jx32 | Units |
|--|--------------------|-------|
| DC Forward Current ^[1] | 700 | mA |
| Peak Pulsing Current | 2400 | mA |
| Power Dissipation | 2730 | mW |
| LED Junction Temperature | 135 | °C |
| Operating Metal Slug Temperature Range at 350 mA | -40 to +120 | °C |
| Operating Metal Slug Temperature Range at 700 mA | -40 to +105 | °C |
| Storage Temperature Range | -40 to + 120 | °C |
| Soldering Temperature | Refer to Figure 15 | |
| Reverse Voltage ^[2] | Not recommended | |

Notes:

1. Derate linearly based on Figure 11.
2. Not designed for reverse bias operation.

Optical Characteristics at 350 mA ($T_J = 25^\circ\text{C}$)

| Part Number | Color | Correlated Color Temperature, CCT (Kelvin) | | Viewing Angle, $2\theta_{1/2}$ [1] ($^\circ$) | Luminous Efficiency (lm/W) |
|-----------------|---------------|--|-------|---|----------------------------|
| | | Min. | Max. | Typ. | Typ. |
| ASMT-JW32-NWY01 | Cool White | 4500 | 10000 | 140 | 125 |
| ASMT-JW32-NWYJ1 | | 5000 | 6300 | 140 | 125 |
| ASMT-JN32-NWY01 | Neutral White | 3500 | 4500 | 140 | 125 |
| ASMT-JN32-NWYH1 | | 3800 | 4500 | 140 | 125 |
| ASMT-JY32-NWY01 | Warm White | 2700 | 3500 | 140 | 116 |
| ASMT-JY32-NWYK1 | | 3050 | 3500 | 140 | 116 |

Note:

1. $\theta_{1/2}$ is the off-axis angle where the luminous intensity is $1/2$ the peak intensity.

Electrical Characteristic at 350 mA ($T_J = 25^\circ\text{C}$)

| Dice Type | Forward Voltage, V_F (Volts) | | | Thermal Resistance, $R_{\theta_{J-MS}}$ ($^\circ\text{C}/\text{W}$) [1] |
|-----------|--------------------------------|------|------|---|
| | Min. | Typ. | Max. | Typ. |
| InGaN | 2.8 | 3.2 | 3.5 | 9 |

Note:

1. $R_{\theta_{J-MS}}$ is Thermal Resistance from LED junction to metal slug.

Optical and Electrical Characteristic at 700 mA ($T_J = 25^\circ\text{C}$)

| Part Number | Color | Luminous Flux (lm), ϕ_V | Forward Voltage, V_F (Volts) |
|-----------------|---------------|------------------------------|--------------------------------|
| | | Typ. | Typ. |
| ASMT-JW32-NWY01 | Cool White | 239.0 | 3.6 |
| ASMT-JW32-NWYJ1 | | 239.0 | 3.6 |
| ASMT-JN32-NWY01 | Neutral White | 239.0 | 3.6 |
| ASMT-JN32-NWYH1 | | 239.0 | 3.6 |
| ASMT-JY32-NWY01 | Warm White | 222.0 | 3.6 |
| ASMT-JY32-NWYK1 | | 222.0 | 3.6 |

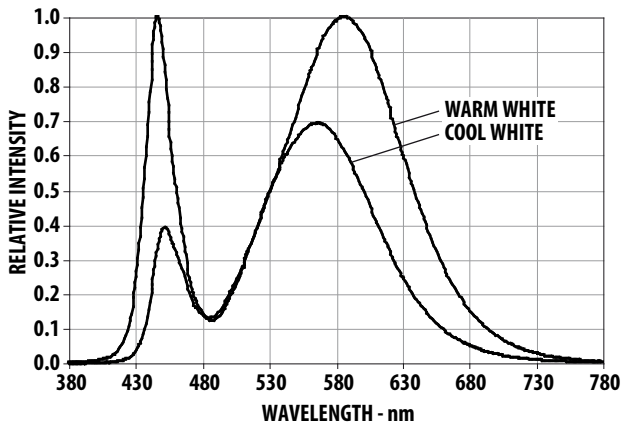

Figure 2. Relative Intensity vs. Wavelength for Cool White and Warm White

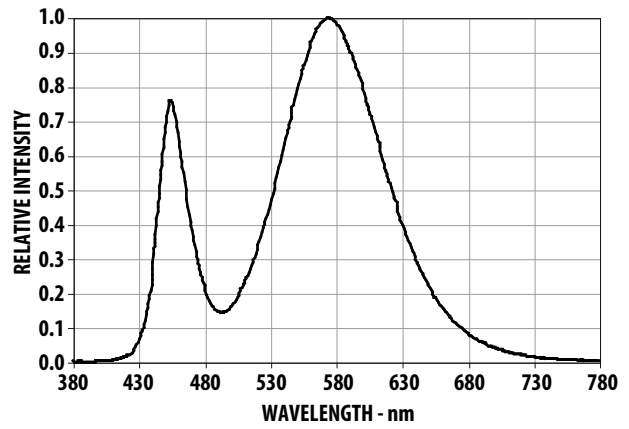

Figure 3. Relative Intensity vs. Wavelength for Neutral White

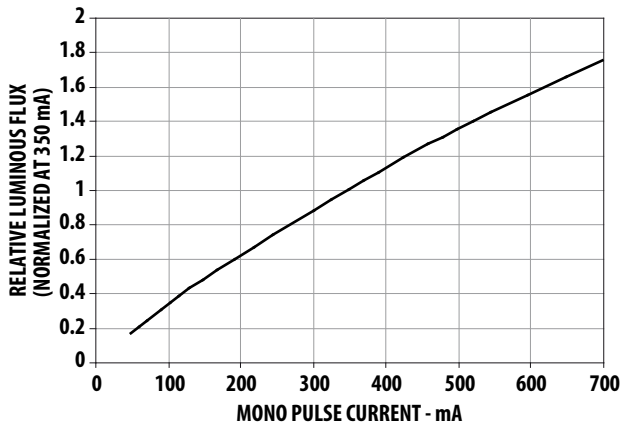

Figure 4. Relative Luminous Flux vs. Mono Pulse Current

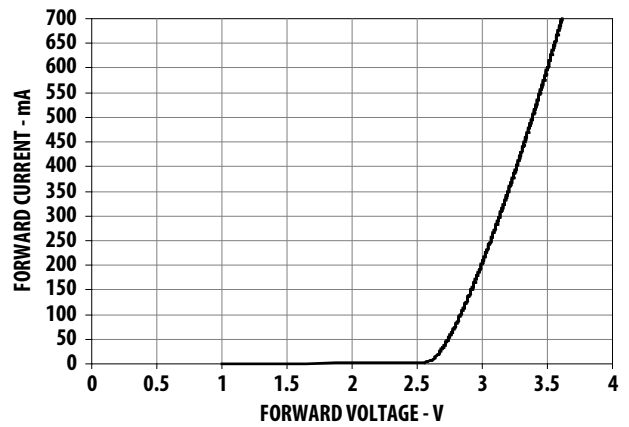

Figure 5. Forward Current vs. Forward Voltage

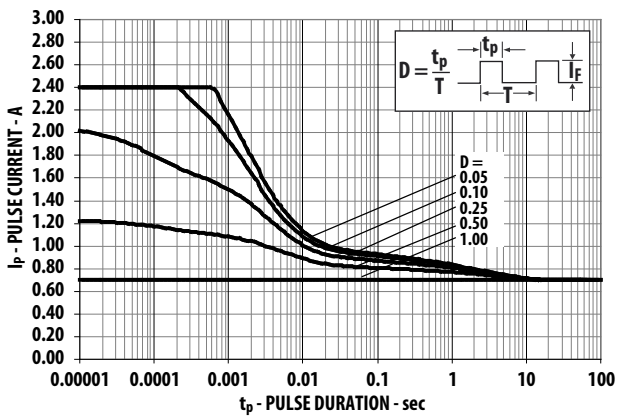

Figure 6. Maximum pulse current vs. pulse duration
Derated based on $T_A = 25^\circ\text{C}$, $R\theta_{J-A} = 30^\circ\text{C/W}$.

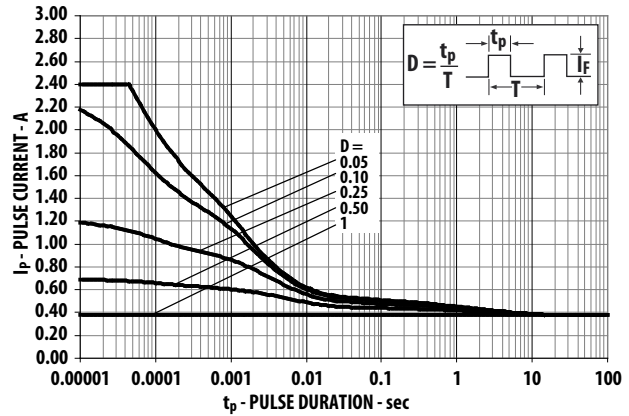

Figure 7. Maximum pulse current vs. pulse duration
Derated based on $T_A = 85^\circ\text{C}$, $R\theta_{J-A} = 30^\circ\text{C/W}$.

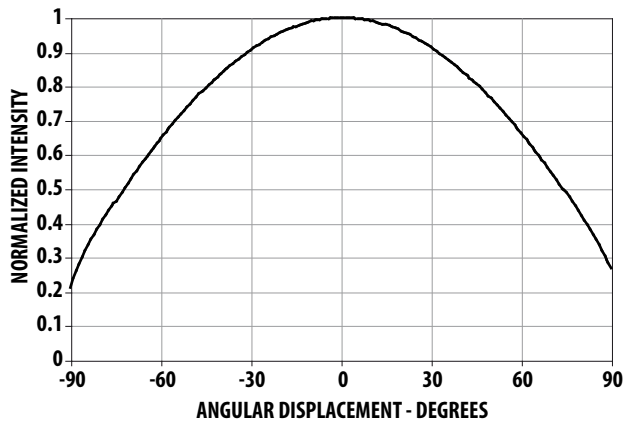

Figure 8. Radiation Pattern for Cool White, Warm White and Neutral White

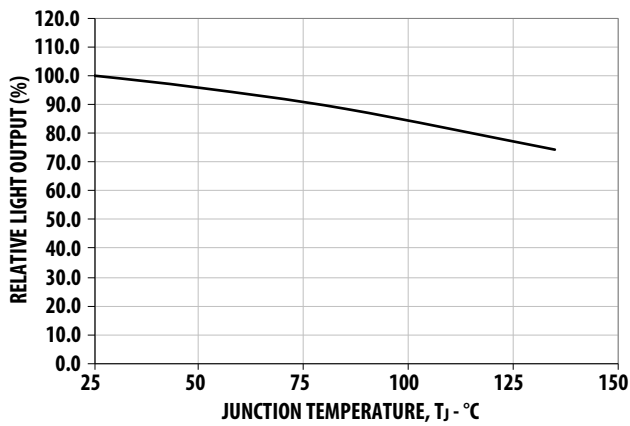

Figure 9. Relative Light Output vs. Junction Temperature

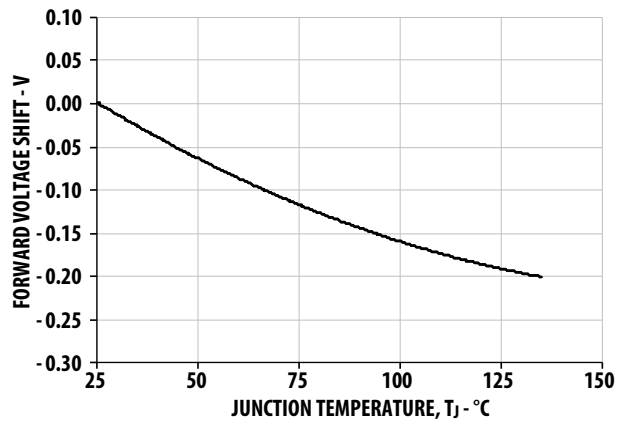

Figure 10. Forward Voltage Shift vs. Junction Temperature

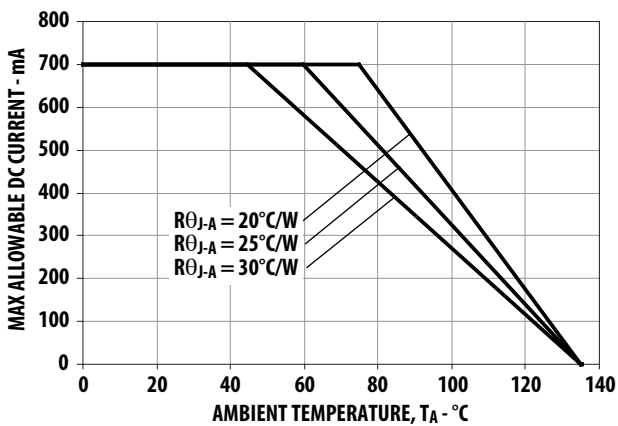

Figure 11. Maximum Forward Current vs. Ambient Temperature. Derated based on $T_{JMAX} = 135^\circ\text{C}$, $R_{\theta J-A} = 20^\circ\text{C/W}$, 25°C/W and 30°C/W

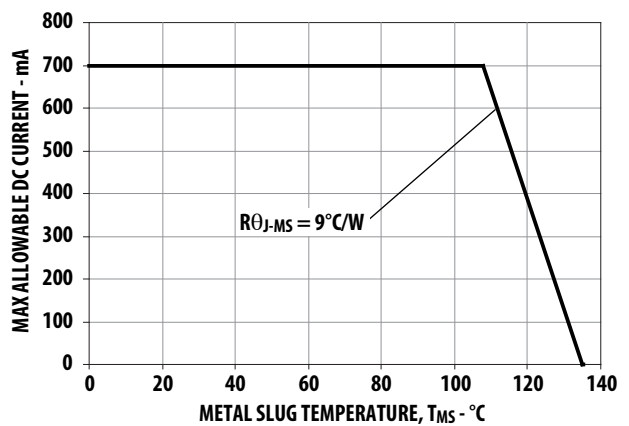

Figure 12. Maximum Forward Current vs. Metal Slug Temperature. Derated based on $T_{JMAX} = 135^\circ\text{C}$, $R_{\theta J-MS} = 9^\circ\text{C/W}$

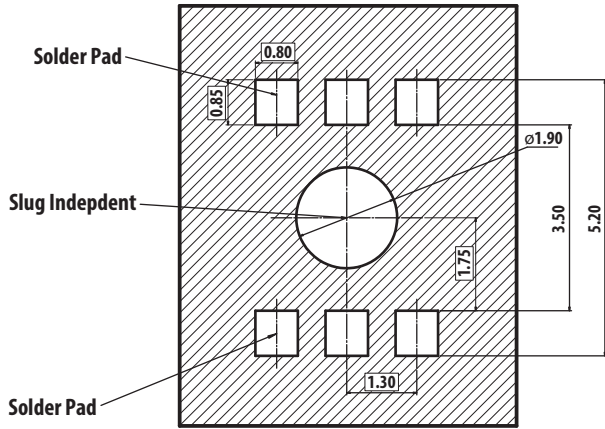

Figure 13. Recommended soldering land pattern

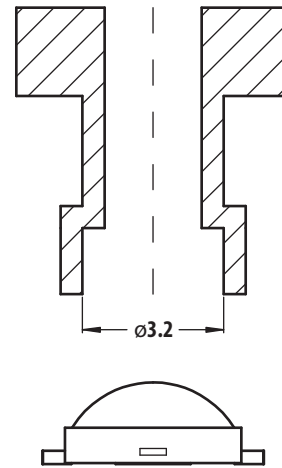

Figure 14. Recommended pick and place nozzle tip. Inner diameter = 3.2 mm

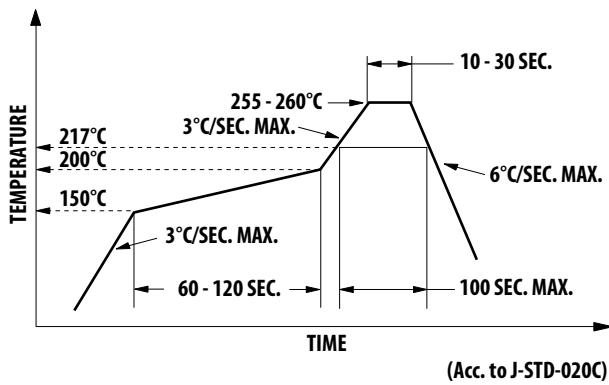

Figure 15. Recommended Reflow Soldering Profile

Note:

For detail information on reflow soldering of Avago surface mount LEDs, do refer to Avago Application Note AN1060 Surface Mounting SMT LED Indicator Components.

Option Selection Details

ASMT-J x₁ 3 2 – x₂ x₃ x₄ x₅ x₆

x₃ – Minimum Flux Bin Selection

x₄ – Maximum Flux Bin Selection

x₅ – Color Bin Selection

x₆ – Packaging Option

Flux Bin Limit [x₃, x₄]

| Bin ID | Luminous Flux (lm) at 350 mA | |
|--------|------------------------------|-------|
| | Min. | Max. |
| U | 87.4 | 99.6 |
| V | 99.6 | 113.6 |
| W | 113.6 | 129.5 |
| X | 129.5 | 147.7 |
| Y | 147.7 | 168.4 |

Color Bin Selection [x₅]

Individual reel will contain parts from one color bin selection only.

Cool White

| Selection | Bin ID |
|-----------|-----------------------|
| 0 | Full Distribution |
| E | VM, UM, VN and UN |
| F | WM, VM, WN and VN |
| G | XM, WM, XN and WN |
| H | UN, VN, U0 and V0 |
| J | WN, VN, W0 and V0 |
| K | XN, WN, X0 and W0 |
| L | V0, U0, VP and UP |
| M | W0, V0, WP, VP and WQ |
| N | X0, W0, XP, WP and WQ |
| P | Y0 |
| Q | YA |

Warm White

| Selection | Bin ID |
|-----------|-------------------|
| 0 | Full Distribution |
| E | NM, MM, N1 and M1 |
| F | PM, NM, P1 and N1 |
| G | QM, PM, Q1 and P1 |
| H | M1, N1, M0 and N0 |
| J | P1, N1, P0 and N0 |
| K | Q1, P1, Q0 and P0 |
| L | N0, M0, NA and MA |
| M | P0, N0, PA and NA |
| N | Q0, P0, QA and PA |

Neutral White

| Selection | Bin ID |
|-----------|-------------------|
| 0 | Full Distribution |
| E | SM, RM, S1 and R1 |
| F | TM, SM, TN and S1 |
| G | S1, R1, S0 and R0 |
| H | TN, S1, T0 and S0 |
| J | S0, R0, SA and RA |
| K | T0, S0, TP and SA |

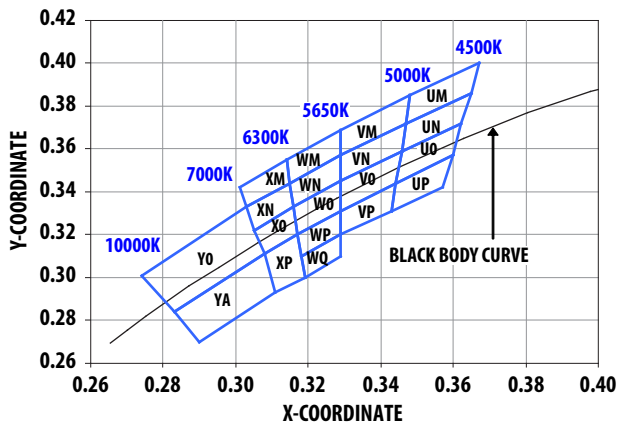

Figure 16. Color bin Structure for Cool White

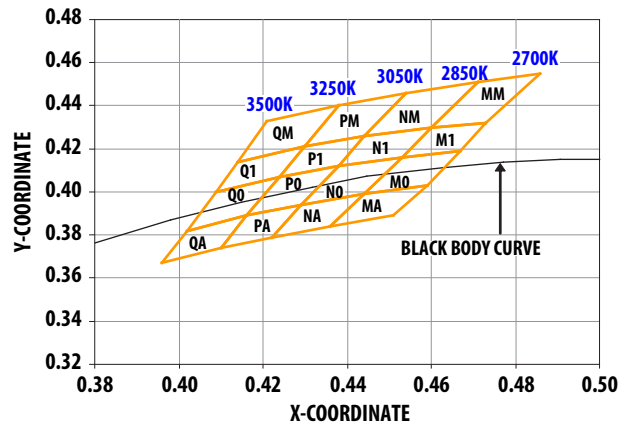

Figure 17. Color bin structure for Warm White

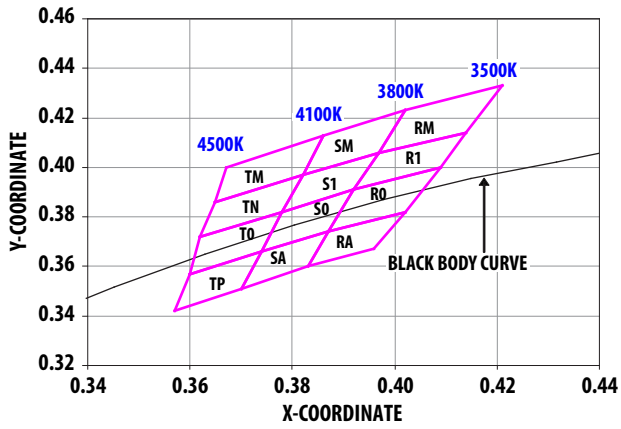

Figure 18. Color bin structure for Neutral White

Color Bin Limits

| Cool White | Color Limits (Chromaticity Coordinates) | | | | |
|-------------------|--|-------|-------|-------|-------|
| Bin UM | x | 0.365 | 0.367 | 0.348 | 0.347 |
| | y | 0.386 | 0.400 | 0.385 | 0.372 |
| Bin UN | x | 0.365 | 0.362 | 0.346 | 0.347 |
| | y | 0.386 | 0.372 | 0.359 | 0.372 |
| Bin U0 | x | 0.362 | 0.360 | 0.344 | 0.346 |
| | y | 0.372 | 0.357 | 0.344 | 0.359 |
| Bin UP | x | 0.360 | 0.357 | 0.343 | 0.344 |
| | y | 0.357 | 0.342 | 0.331 | 0.344 |
| Bin VM | x | 0.329 | 0.329 | 0.348 | 0.347 |
| | y | 0.357 | 0.369 | 0.385 | 0.372 |
| Bin VN | x | 0.329 | 0.329 | 0.347 | 0.346 |
| | y | 0.345 | 0.357 | 0.372 | 0.359 |
| Bin V0 | x | 0.329 | 0.329 | 0.346 | 0.344 |
| | y | 0.331 | 0.345 | 0.359 | 0.344 |
| Bin VP | x | 0.329 | 0.344 | 0.343 | 0.329 |
| | y | 0.331 | 0.344 | 0.331 | 0.320 |
| Bin WM | x | 0.329 | 0.329 | 0.315 | 0.314 |
| | y | 0.369 | 0.357 | 0.344 | 0.355 |
| Bin WN | x | 0.329 | 0.316 | 0.315 | 0.329 |
| | y | 0.345 | 0.333 | 0.344 | 0.357 |
| Bin W0 | x | 0.329 | 0.329 | 0.317 | 0.316 |
| | y | 0.345 | 0.331 | 0.320 | 0.333 |
| Bin WP | x | 0.329 | 0.329 | 0.318 | 0.317 |
| | y | 0.331 | 0.320 | 0.310 | 0.320 |
| Bin WQ | x | 0.329 | 0.329 | 0.319 | 0.318 |
| | y | 0.320 | 0.310 | 0.300 | 0.310 |
| Bin XM | x | 0.301 | 0.314 | 0.315 | 0.303 |
| | y | 0.342 | 0.355 | 0.344 | 0.333 |
| Bin XN | x | 0.305 | 0.303 | 0.315 | 0.316 |
| | y | 0.322 | 0.333 | 0.344 | 0.333 |
| Bin XO | x | 0.308 | 0.305 | 0.316 | 0.317 |
| | y | 0.311 | 0.322 | 0.333 | 0.320 |
| Bin XP | x | 0.308 | 0.317 | 0.319 | 0.311 |
| | y | 0.311 | 0.320 | 0.300 | 0.293 |
| Bin YO | x | 0.308 | 0.283 | 0.274 | 0.303 |
| | y | 0.311 | 0.284 | 0.301 | 0.333 |
| Bin YA | x | 0.308 | 0.311 | 0.290 | 0.283 |
| | y | 0.311 | 0.293 | 0.270 | 0.284 |

Tolerance: ± 0.01

| Warm White | Color Limits (Chromaticity Coordinates) | | | | |
|-------------------|--|-------|-------|-------|-------|
| Bin MM | x | 0.471 | 0.460 | 0.473 | 0.486 |
| | y | 0.451 | 0.430 | 0.432 | 0.455 |
| Bin M1 | x | 0.460 | 0.453 | 0.467 | 0.473 |
| | y | 0.430 | 0.416 | 0.419 | 0.432 |
| Bin M0 | x | 0.453 | 0.444 | 0.459 | 0.467 |
| | y | 0.416 | 0.399 | 0.403 | 0.419 |
| Bin MA | x | 0.459 | 0.444 | 0.436 | 0.451 |
| | y | 0.403 | 0.399 | 0.384 | 0.389 |
| Bin NM | x | 0.454 | 0.444 | 0.460 | 0.471 |
| | y | 0.446 | 0.426 | 0.430 | 0.451 |
| Bin N1 | x | 0.444 | 0.438 | 0.453 | 0.460 |
| | y | 0.426 | 0.412 | 0.416 | 0.430 |
| Bin N0 | x | 0.438 | 0.429 | 0.444 | 0.453 |
| | y | 0.412 | 0.394 | 0.399 | 0.416 |
| Bin NA | x | 0.444 | 0.429 | 0.422 | 0.436 |
| | y | 0.399 | 0.394 | 0.379 | 0.384 |
| Bin PM | x | 0.438 | 0.430 | 0.444 | 0.454 |
| | y | 0.440 | 0.421 | 0.426 | 0.446 |
| Bin P1 | x | 0.430 | 0.424 | 0.438 | 0.444 |
| | y | 0.421 | 0.407 | 0.412 | 0.426 |
| Bin P0 | x | 0.424 | 0.416 | 0.429 | 0.438 |
| | y | 0.407 | 0.389 | 0.394 | 0.412 |
| Bin PA | x | 0.429 | 0.416 | 0.410 | 0.422 |
| | y | 0.394 | 0.389 | 0.374 | 0.379 |
| Bin QM | x | 0.421 | 0.414 | 0.430 | 0.438 |
| | y | 0.433 | 0.414 | 0.421 | 0.440 |
| Bin Q1 | x | 0.414 | 0.409 | 0.424 | 0.430 |
| | y | 0.414 | 0.400 | 0.407 | 0.421 |
| Bin Q0 | x | 0.409 | 0.402 | 0.416 | 0.424 |
| | y | 0.400 | 0.382 | 0.389 | 0.407 |
| Bin QA | x | 0.416 | 0.402 | 0.396 | 0.410 |
| | y | 0.389 | 0.382 | 0.367 | 0.374 |

Tolerance: ± 0.01

| Neutral White | Color Limits (Chromaticity Coordinates) | | | | |
|---------------|---|-------|-------|-------|-------|
| | | x | y | z | u |
| Bin RM | x | 0.421 | 0.414 | 0.397 | 0.402 |
| | y | 0.433 | 0.414 | 0.406 | 0.423 |
| Bin R1 | x | 0.414 | 0.409 | 0.392 | 0.397 |
| | y | 0.414 | 0.400 | 0.391 | 0.406 |
| Bin R0 | x | 0.392 | 0.387 | 0.402 | 0.409 |
| | y | 0.391 | 0.374 | 0.382 | 0.400 |
| Bin RA | x | 0.387 | 0.383 | 0.396 | 0.402 |
| | y | 0.374 | 0.360 | 0.367 | 0.382 |
| Bin SM | x | 0.402 | 0.397 | 0.382 | 0.386 |
| | y | 0.423 | 0.406 | 0.397 | 0.413 |
| Bin S1 | x | 0.397 | 0.392 | 0.378 | 0.382 |
| | y | 0.406 | 0.391 | 0.382 | 0.397 |
| Bin S0 | x | 0.392 | 0.387 | 0.374 | 0.378 |
| | y | 0.391 | 0.374 | 0.366 | 0.382 |
| Bin SA | x | 0.387 | 0.383 | 0.370 | 0.374 |
| | y | 0.374 | 0.360 | 0.351 | 0.366 |
| Bin TM | x | 0.386 | 0.382 | 0.365 | 0.367 |
| | y | 0.413 | 0.397 | 0.386 | 0.400 |
| Bin TN | x | 0.382 | 0.378 | 0.362 | 0.365 |
| | y | 0.397 | 0.382 | 0.372 | 0.386 |
| Bin T0 | x | 0.378 | 0.374 | 0.360 | 0.362 |
| | y | 0.382 | 0.366 | 0.357 | 0.372 |
| Bin TP | x | 0.374 | 0.370 | 0.357 | 0.360 |
| | y | 0.366 | 0.351 | 0.342 | 0.357 |

Tolerance: ± 0.01

Packaging Option [x₆]

| Selection | Option |
|-----------|---------------|
| 1 | Tape and Reel |

Example

ASMT-JW32-NUV01

ASMT-JW32-Nxxxx – Cool White, InGaN,
Electrically isolated Heat Sink

- X₃ = U – Minimum Flux Bin U
- X₄ = V – Maximum Flux Bin V
- X₅ = 0 – Full Distribution
- X₆ = 1 – Tape and Reel Option

Tape and Reel – Option 1

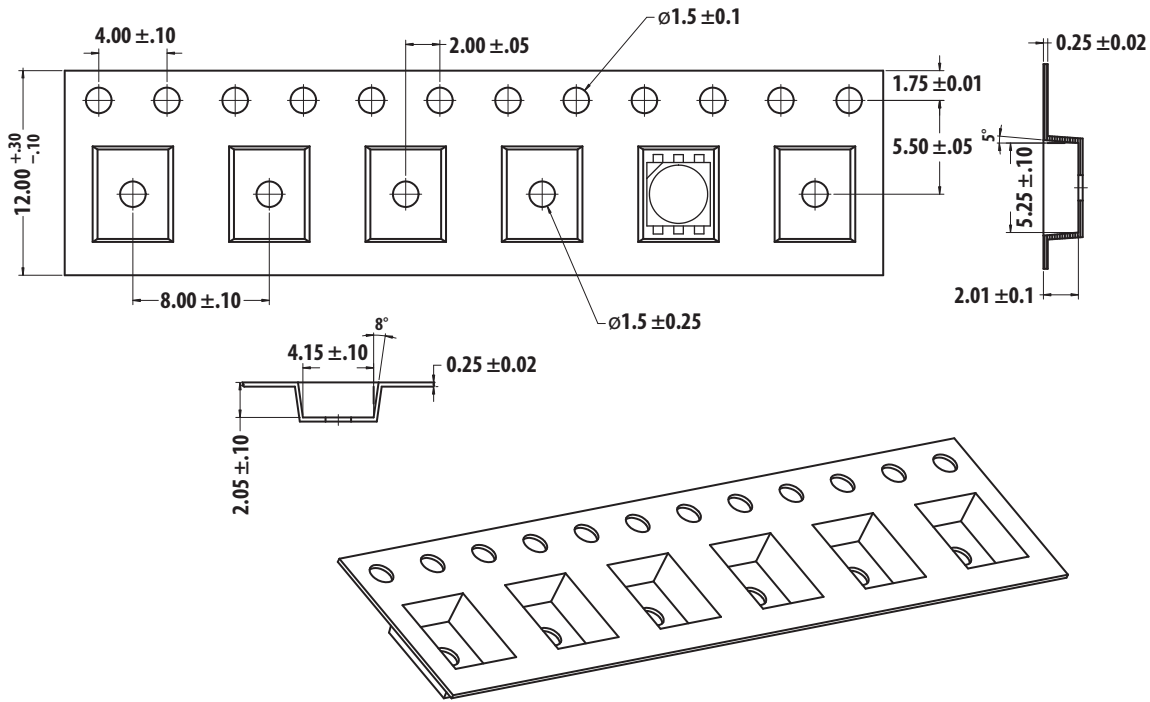
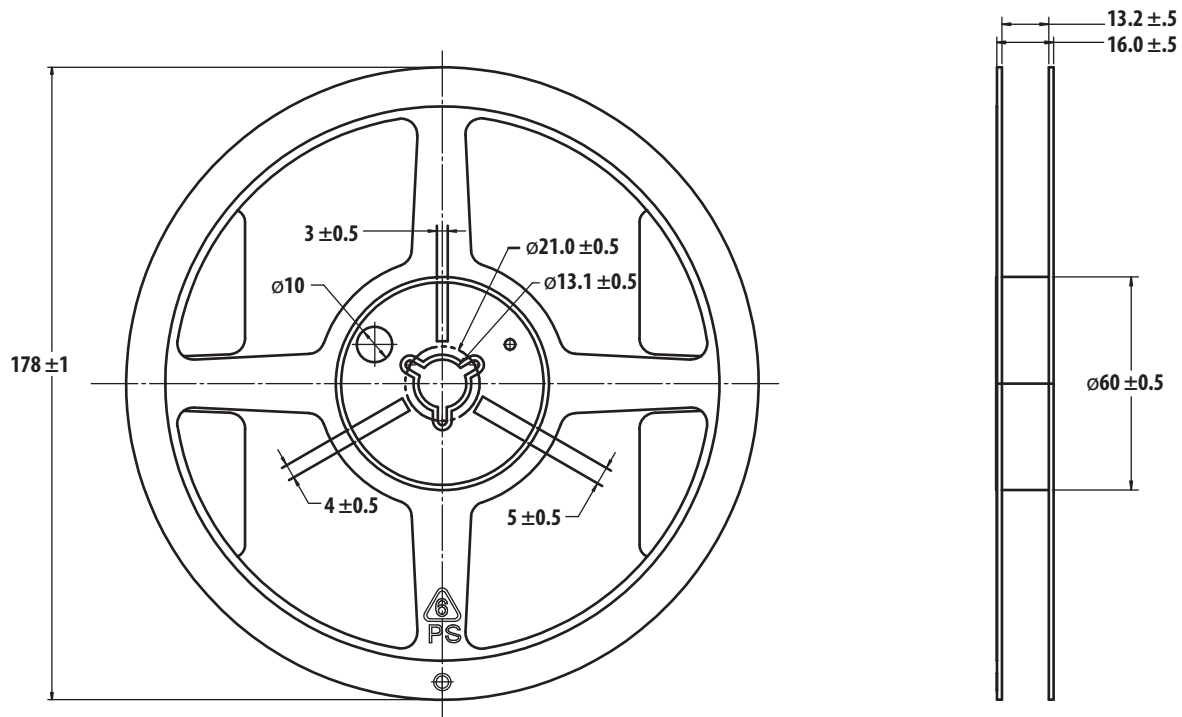

Figure 19. Carrier Tape Dimensions



Notes:

1. Empty component pockets sealed with top cover tape.
2. 250 or 500 pieces per reel.
3. Drawing not to scale.
4. All dimensions are in millimeters.

Figure 20. Reel dimensions

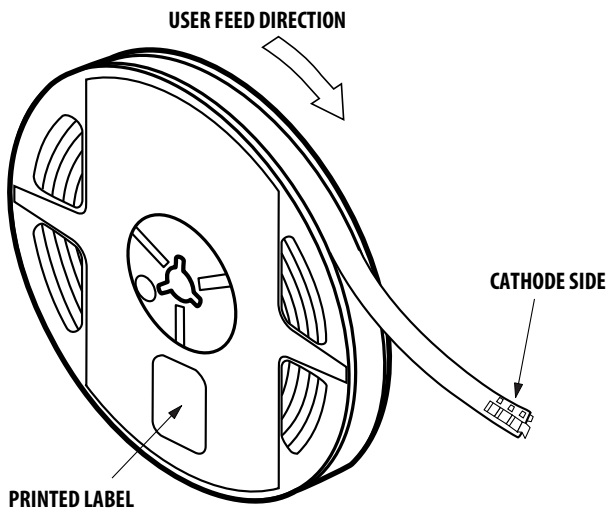

Figure 21. Reeling Orientation

DISCLAIMER: Avago's products and software are not specifically designed, manufactured or authorized for sale as parts, components or assemblies for the planning, construction, maintenance or direct operation of a nuclear facility or for use in medical devices or applications. Customer is solely responsible, and waives all rights to make claims against avago or its suppliers, for all loss, damage, expense or liability in connection with such use.

For product information and a complete list of distributors, please go to our web site: www.avagotech.com

Avago, Avago Technologies, and the A logo are trademarks of Avago Technologies in the United States and other countries. Data subject to change. Copyright © 2005-2015 Avago Technologies. All rights reserved.
AV02-2428EN - February 2, 2015

AVAGO
TECHNOLOGIES