

Alle Rechte vorbehalten/ All rights reserved

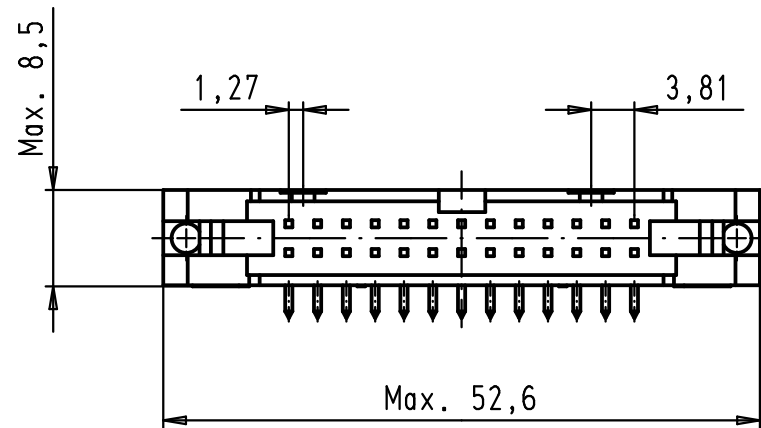

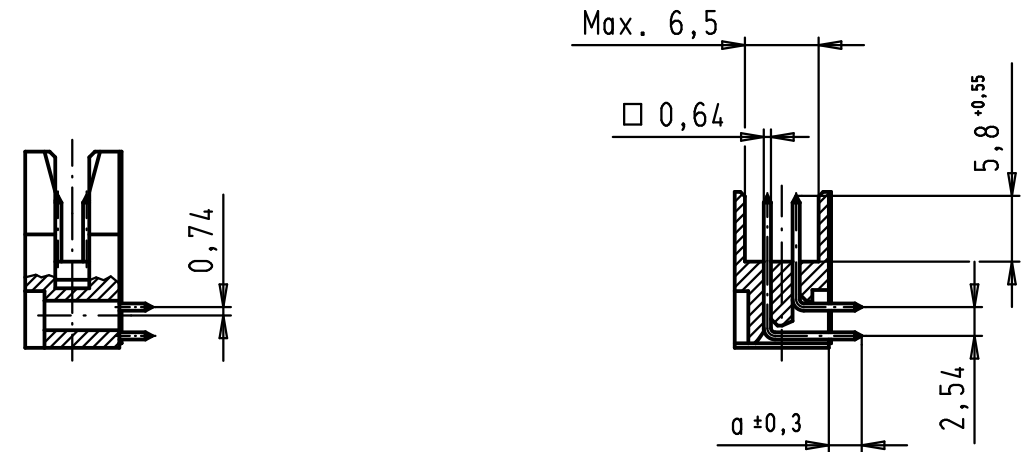

PCB layout, component side

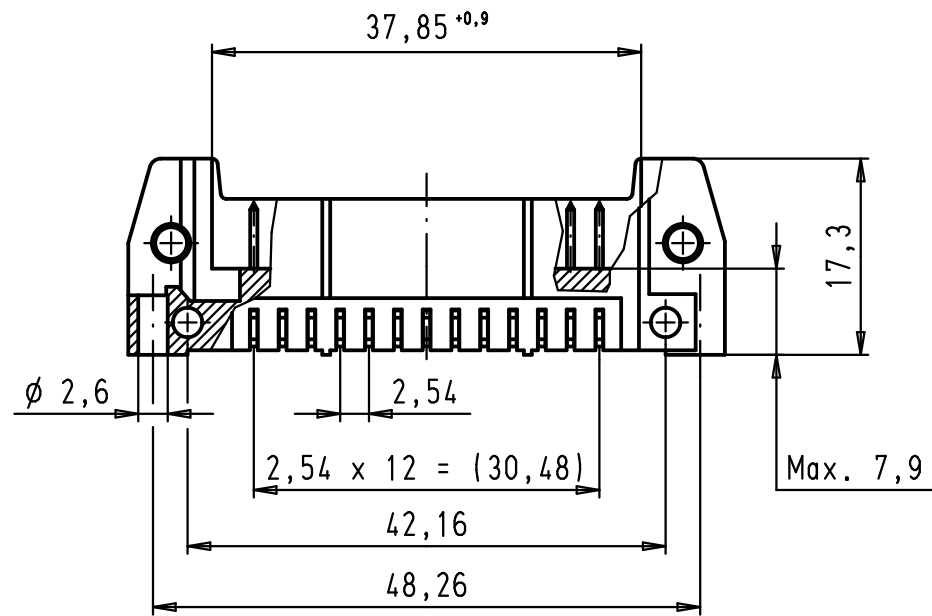
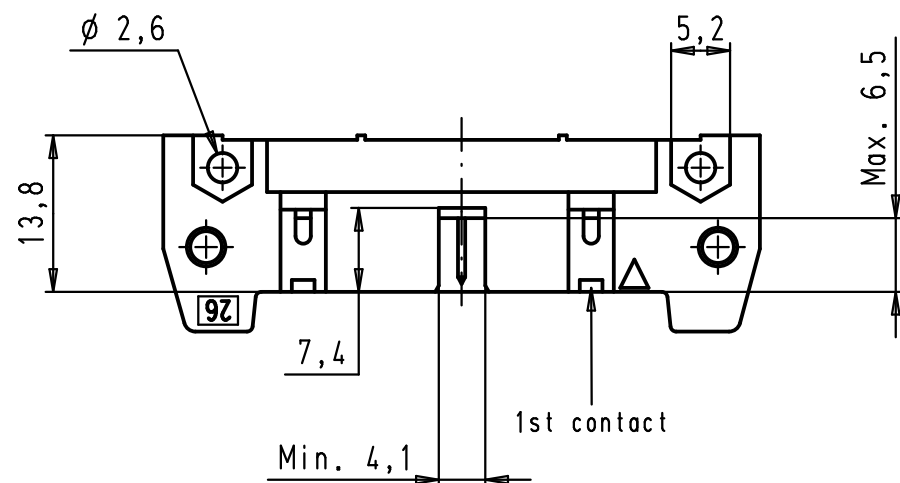
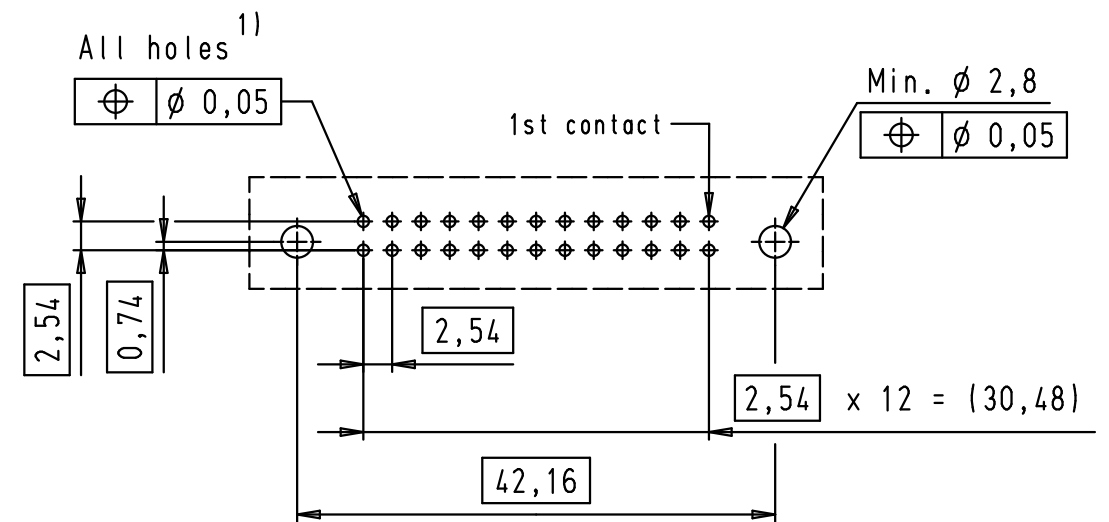

1) Solder pins for PCB connections
 $\phi 1 \pm 0,1$ according to IEC 60 326-3

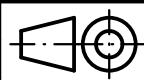
09 18 526 7921	3	4,5
09 18 526 6921	2	4,5
09 18 526 5921	0,76 $\mu\text{m Au}$	4,5
09 18 526 7923	3	2,9
09 18 526 6923	2	2,9
09 18 526 5923	0,76 $\mu\text{m Au}$	2,9
Part number	Performance level	a

				Det.	Name	 All Dim. in mm Orig. Size DIN A 3	SEK 18 Male Connector Standard 26 poles Angled pins Without locking levers	Maßstab/ Scale
34890	01/02/08	PK	Detail.	01/12/99	JB			1,5:1
29753	11/03/02	JB	Insp.					
29739	03/12/01	JB	Stand.					
27931	15/06/00	JB						
26554	01/12/99	JB						
Mod.	Det.	Name	HARTING EURL F-95972 Paris				TB 09 18 526 X92X	Blatt/ Page
							Sub.	2 2